

The background of the entire page is a vibrant yellow. It is decorated with a scattered pattern of various geometric shapes. Some shapes are solid pink, including circles, triangles, pentagons, and wavy lines. Others are white outlines of the same shapes. The shapes are distributed across the page, creating a playful and modern aesthetic.

ACCESSORIES 2023
C A T A L O G U E

 **ivars** Accessories

Accessories

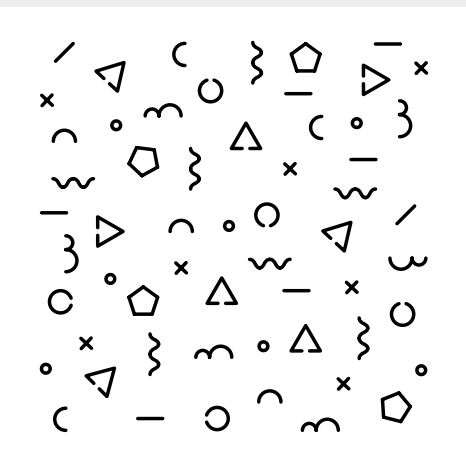

IVARS

Un solo pattern, tante sfumature.
One unique pattern, many nuances.

Da sempre, siamo alla **ricerca dell'innovazione in ogni ambito, sperimentando gusti e tendenze** che rendono ogni giorno il nostro lavoro ricco di novità.

La scelta di aggiungere **un tocco di creatività ai nostri Cataloghi IVARS** è data dalla costante ricerca di ciò che di nuovo richiede il mercato: capacità di stare al passo coi tempi, intuito su ciò che rende accattivante un prodotto e coraggio di stravolgere i piani, andando incontro ai nuovi canoni che il marketing e la comunicazione impongono.

Colori accesi, forme geometriche e rimandi che renderanno ogni copertina unica.

Un solo pattern, tante sfumature che andranno a modellarsi in un unico grande progetto.

*We've always sought to **innovate in every area of our business, experimenting with new tastes and trends**, and this approach ensures our daily work is brimming with new ideas.*

*Our decision to add **a touch of creativity to our IVARS Catalogues** comes from our constant quest for those new ideas the market requires: our strength is our ability to keep up with the times, our intuition about what makes a product captivating, and our courage to re-evaluate plans to meet the new canons imposed by marketing and communication.*

Bright colours, geometric shapes, and references lend a unique style to each cover.

***One unique pattern, many nuances** that come together to make a great unified project.*

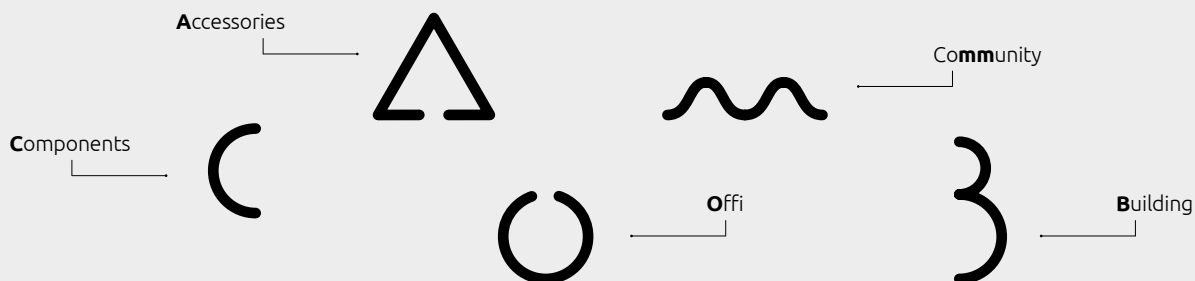



Con voi, nella scelta di ogni dettaglio! *With you, in the choice of every detail!*

Il **Catalogo Accessori 2023** è la sintesi perfetta di come ogni singolo dettaglio può fare la differenza. Gli Accessori Ivars sono nelle case e negli uffici d tutto il mondo da ben 75 anni.

Un successo che ha portato l'azienda a credere sempre più nell'importanza di ogni particolare, tornando con **un nuovo catalogo** che, con la sua tradizionale e vasta gamma di prodotti, punta ad essere **sempre più aggiornato e diversificato**.

L'offerta Ivars della divisione Accessori, estremamente versatile nella disponibilità di modelli e misure, è funzionale a numerosi ambiti: dall'arredamento in legno e in metallo al "fai da te", dal settore ferramenta fino a quello medico ospedaliero. Puntali, copritesta, piedini regolabili, ruote, che trovano la loro perfetta collocazione nei più svariati settori.

Le proposte sono Made in Italy, progettate e prodotte presso la nostra sede.

Da 75 anni scegliamo di essere al vostro fianco ogni giorno: a casa, in ufficio, in Italia e in tutto il mondo.

Buona consultazione.

Ivars Accessories

*The **2023 Accessories Catalogue** represents the perfect synthesis of how it's the single details that really make the difference. Ivars Accessories have been in homes and offices all over the world for over 75 years now.*

*This success serves to affirm our belief in the importance that every single detail can make, and to publish **a new catalogue** which, with its traditional and extensive range of products, endeavours to remain **constantly up to date and increasingly diversified**.*











































With its large selection of available models and sizes, the Ivars Accessories Division's product range provides great versatility, offering numerous functional solutions for a great many sectors: from wooden and metal furniture to DIY to hardware and the medical and hospital sectors. Tips, headrest covers, adjustable feet, and wheels for a multitude of uses in a huge variety of industries.























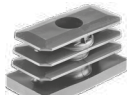

















As always, the entire range of products in the catalogue are proudly Made in Italy, and designed and manufactured by us at our premises. For 75 years we have chosen to be constantly by your side every day: at home, in the office, in Italy and all over the world.

Enjoy.

Ivars Accessories

INDICE | Index

01 Puntali per interno rotondi Round tube inserts							18
							
IRA pg.18	IRA1 pg.18	IRA2 pg.18	IRAP pg.19	IRAFS pg.19	IRAF pg.19	IRG pg.20	IRGI pg.20
							
IRG pg.20	PTL pg.21	ITR pg.21	ITR pg.21	IRN pg.22	IRAI pg.22	IRAI pg.22	IRZI pg.23
							
ITSA pg.23	ITSA pg.23	ITSA2 pg.24	ITLA pg.24	IRTA pg.24	IRF pg.24		
02 Copritesta rotondi Tube cover round inserts							25
							
CCR pg.25	CCRA pg.25	CCRN pg.25	CCRC pg.26	CCRL pg.26	CTM pg.26	CRM pg.27	ITSC pg.27
							
CS pg.27	CM pg.28	CGR pg.29					
03 Puntali quadri Square tube inserts							30
							
QIA pg.30	QIA pg.30	QIA pg.30	QIAS pg.30	QAI pg.31	QI pg.31	QIZ pg.31	QAF pg.31
 							
QAFI pg.32							

04	Copritesta quadri Tube cover square inserts						33
							
CQI pg.33	CQIN pg.33	ITSQ pg.33	CQM pg.33	CGQ pg.34	CGQ pg.34	QIAF pg.34	
05	Puntali rettangolari Rectangular tube cover inserts						35
							
RIA pg.35	CRI pg.36	RAI pg.36	RIZ pg.36	RIAS pg.36	RAF pg.37	RAFI pg.37	
06	Copritesta rettangolari Rectangular tube cover inserts						38
							
CRI pg.38	CRIN pg.38	CRIE pg.38	CRIS pg.39	CRTM pg.39	CRG pg.39		
07	Puntali a ellisse e ovali Elliptical and oval inserts						40
							
EIA pg.40	EIAS pg.40	EIAI pg.40	EIAD pg.40	EIADI pg.41	OIA pg.41	OIADI pg.41	OIAS pg.41
							
PIO pg.42	PIO pg.42	OAF pg.42	PCSO pg.42	COM pg.43	CEI pg.43	CEIS pg.43	COC pg.43
							
COI pg.44	CPTA pg.44	CPTA1 pg.44	CONI pg.45	CENI pg.45			

08	Basi piane a pinza per telai a filo Clips for chair wire metal frames	46
-----------	---	-----------



09	Puntali per esterno Outer caps	50
-----------	--	-----------

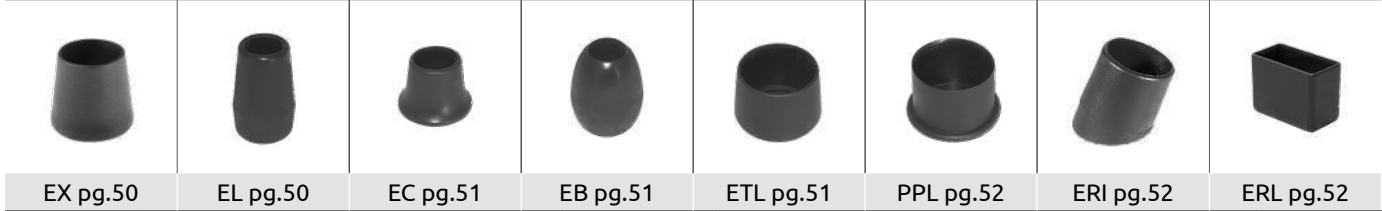

10	Puntali ovali e piedi scale Oval inserts and ladder feet	53
-----------	--	-----------









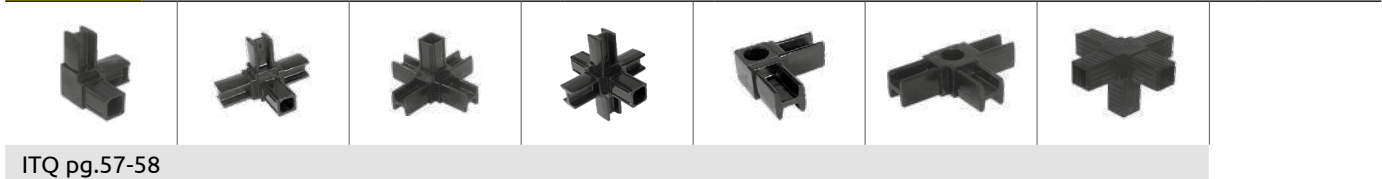



11	Puntali per scaffalature Inserts for shelving units	55
-----------	---	-----------







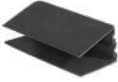















12	Innesti per tubi Tube connectors	57
-----------	--	-----------



13	Articoli vari Various articles	59
----	--	----

						 <small>NEW</small>	
RL pg.59	CFS pg.59	PAT pg.59	MAC pg.59	PRM pg.60	PRM pg.60	PRMS pg.60	PRMT pg.61
	 <small>NEW</small>						
PMS pg.61	CD pg.61						









14	Accessori per sedie Fittings for chairs	62
----	---	----









							
SP pg.62	SPL pg.62	SPQ pg.62	SPBT pg.63	DP pg.63	AS pg.63	P2P pg.64	P2PA pg.64
							
P2PF pg.64	PAR pg.64	PARP pg.65	PART pg.65	PATS pg.65	CSPR pg.66	CSB pg.66	PSL pg.66
							
PTF pg.66	PTT pg.66	AGO pg.67	BS pg.67	BSB pg.67			

15	Puntali a mezza sfera a scatto Snap inserts	68
----	---	----



							
MSP pg.68	MS pg.68	MSE pg.68	MSSP pg.68	MSS pg.68			

16	Distanziatori e paracolpi Spacers and buffers	69
----	---	----

							
TD pg.69	TDE pg.69	DB pg.69	DR pg.69	TC pg.70	TDI pg.70	DZC pg.70	DZB pg.70

							
DZL pg.70	PT pg.71	RSS pg.71	PIT pg.71	PIC pg.71	FBP pg.72	TFS pg.72	RP pg.72

17	Paracolpi a fungo Mushroom-shaped buffer	73
-----------	--	-----------

							
PF1 pg.73	PF2 pg.73	PF3 pg.73-74	PF4 pg.74	PF5 pg.74	PF13 pg.74	PF14 pg.74	PF3B pg.75
							
PF15 pg.75	PF16 pg.75	P4P pg.75	PFF pg.75				

18	Paracolpi a scatto Snap buffer	76
-----------	--	-----------





							
PF7 pg.76	PF9 pg.76	PF10 pg.76	PF12 pg.76				

19	Paracolpi con chiodo Buffers with nail	77
-----------	--	-----------





























							
PF6 pg.77	PF8 pg.77	PC pg.77	PBF c pg.78	PP pg.78	PPP pg.78		

20	Articoli per reti e letti metallo Articles for bed frames and nets	79
-----------	--	-----------

							
IQC pg.79	IRC pg.79	PFB pg.79	PFB pg.80	PFB pg.80	CPR pg.81	CPRX pg.81	PUS pg.81
							
GPL pg.82	GPLD pg.82	RAR pg.82	CMR pg.83	RAP pg.83	RAPAL pg.83	EBI pg.83	PPL pg.84

					
PTL pg.84	STL pg.84	SARE pg.84	SAGE pg.85	CRL pg.85	

21	Articoli per attaccapanni e portaombrelli Articles for coat hangers and umbrella stands	86
-----------	--	-----------

							
HA01 pg.87	APP pg.87	MXA pg.87	CPA pg.87	AP4 pg.87	PFS pg.88	PAP pg.88	PPS pg.88
							
PATC pg.88	ITRV pg.89	AXA pg.89	ITR pg.89	ITR pg.90	VIT pg.90	GGA pg.90	DPO pg.91
							
DPOQ pg.91	DPOC pg.91	DU01 pg.91	CSA pg.91	BPO pg.92	BPO pg.92	BPO pg.92	PU01 pg.92
							
PORB pg.92	HM01 pg.93	AO2 pg.93	AO pg.93				

22	Articoli per spogliatoi Changing rooms items	94
-----------	---	-----------

							
PAS pg.95	PGO pg.95	GPO pg.95	VPO pg.95	GPG pg.95	GRA pg.96	GAS pg.96	GASD pg.96

23	Accessori per tavolini e carrelli Items for tables and trolleys	97
-----------	--	-----------

							
VG pg.97	VS pg.97	RR pg.97	3R pg.98	RML pg.98	RBV pg.98	FCV pg.98	

24

Articoli per mobili scuola e ufficio

Various items for school and office

99

							
PGP pg.100	VLG pg.100	PPG pg.100	PQR pg.101	PCS pg.101	CSO pg.101	CSL pg.101	CSS pg.102
							
VC pg.102	RC pg.102	PR pg.103	MR pg.103	SFS pg.103	PQS pg.103	POS pg.105	POSF pg.105
							
POSL pg.105	POSG pg.106	POSGF pg.106	POSL pg.106	POSGS pg.107	POSR pg.107	CPOP pg.109	CPO pg.109
							
GCS pg.109	CESG pg.110	PODI pg.110					

25

Articoli medico-ospedalieri

Hospital-medical articles

111





							
IPF pg.112	APF2 pg.112	ASPF pg.112	RBS pg.113	RBSS pg.113	RBSL pg.113		

26

Articoli per mobili legno

Articles for wooden furniture

114

							
BLR pg.114	CVIE pg.114	RS pg.114	BCM pg.114	FP pg.115	P2GL pg.115	PFM pg.115	









27

Maniglie per mobili

Handles for furniture

116

							
MOB pg.116	MTT pg.116	MDA pg.116	MDB pg.116	MMC pg.116	MCL pg.117	MCE pg.117	MF pg.117

								
RMF pg.118	MML pg.118							
28	Maniglie da incasso Recessed handles						119	
								
MI pg.119	MIS pg.119	MIR pg.119						
29	Pomoli vari Knobs						120	
								
PBC pg.120	POMC pg.120	PFS pg.120						
30	Volantini con gambo Star knobs						121	
								
NEW	VGF pg.121	VJB pg.121	VJBB pg.121	VJA pg.121	VJAB pg.122	VJS pg.122	VJSB pg.122	VSE pg.122
								
VSEB pg.123	VGJ pg.123	VTB pg.123	V3O pg.123	VZF pg.124	VPHA pg.124	VPR pg.124	VGE pg.124	
31	Volantini ciechi Blind knobs						125	
								
VCF pg.125	VJF pg.125	VZC pg.125	VFP pg.126	VCE pg.126				
32	Dadi con alette Nuts with tongues						127	
								
DGA pg.127	DCA pg.127							

33**Bussole**
Nuts**128**

B4G pg.128



BAR pg.128

34**Piedini regolabili**
Adjustable feet**129**

PRA pg.129



PRB pg.129



PRC pg.129



PRD pg.129



RFR pg.130



PREG pg.130



PBRB pg.130



PBRC pg.130



PBRD pg.131



PRP pg.131



PCR pg.131



RBA pg.131



PRS pg.132



RPN pg.132



PGS pg.132



PASA pg.132



RPMG pg.132



RPM pg.133



PRG pg.133



PGT pg.133



PRGB pg.133



PRGC pg.134



VPHA pg.134



VPR pg.134



PBZ pg.134



VPH pg.135



PRBG pg.135



PREP pg.135



PPML pg.135



PMU pg.136



PMU4 pg.136



PMUC pg.136



IVC pg.136



IVC pg.136



IVC pg.136



IVR pg.137



PGSR pg.137



pg.137



PFPA pg.137

35**Piedini snodati orientabili**
Adjustable tilt glides**138**

PS pg.138



PSC pg.138



PSD pg.138



PSA pg.138



PSB pg.138



PSE-PSG pg.139



PSF pg.139



PSH pg.139



PSE4 pg.139



PSE5 pg.140



PSE8 pg.140



PSE9 pg.140



PSE9F pg.140







































ES pg.141



PSEP pg.141



PGSI pg.141

							
PGSA pg.141	PSRS pg.141						
36	Piedini per cucina Feet for kitchen furniture						142
							
PTGC pg.143	PFGC pg.143	GZC pg.143	SGC pg.143	PSGC pg.144	GZCI pg.144	- pg.144	
37	Componenti per mobili Components for furniture						145
							
PDBT pg.145	PPDA pg.145	ADP pg.146					
38	Piedini basi girevoli Glides for chairs and furniture						147
							
GLIS pg.147	GLISC pg.147	GLIC pg.147	GLICC pg.148	GLIO pg.148	GLIA pg.148	GLIT pg.148	GLIP pg.149
							
GLICI pg.149							
39	Doppie ruote pivotanti Ø65 Twin-castors Ø65						150
							
DRH pg.150	DRHA pg.150	DRHD pg.150	DRHAD pg.151	DRHB pg.151	DRHC pg.151	DRHDC pg.152	
40	Doppie ruote pivotanti Ø50 (1) Twin-castors Ø50 (1)						153
							
DRG pg.153	DRA pg.153	DRS pg.153	DRGC pg.154	DRV pg.154	DRVA pg.154	DRAD pg.155	DRSD pg.155

							
DRVD pg.155	DRVAD pg.156	DRGDC pg.156	DRGD pg.156	DRCB pg.157	DRM pg.157	DRK pg.157	DRKA pg.158
							
DRKD pg.158	DRKAD pg.158	DRN pg.159	DRC pg.159	DRGR pg.159			

41

Doppie ruote pivotanti Ø47-40-36-35-30 (1)
Twin-castors Ø47-40-36-35-30 (1)

160

							
RTL pg.160	DRC pg.160	DRBL pg.160	DRBLB pg.161	DRB pg.161	DRBD pg.161	DRPF pg.162	pg.162
							
SRPL pg.164	pg.164	GRP pg.164					

42

Perni per ruote e basi pivotanti (1)
Fittings for twin - castors (1)

165

							
GPB pg.165	GFR pg.165	GPR pg.165	GHI pg.165	BHI pg.165	GGR pg.165		

43

Doppie ruote pivotanti Ø50 (2)
Twin - castors Ø50 (2)

166

							
OTO50 pg.166	OTO50CF pg.166	OTO50RG pg.166	OTO50RGCF pg.166				

44

Doppie ruote pivotanti Ø40-35 (2)
Twin - castors Ø40-35 (2)

167

							
OTO40 pg.167	OTO40CF pg.167	OTO40RG pg.167	SAR40 pg.167	SAR35 pg.168	ECO35 pg.168		



45	Perni per ruote pivotanti (2) OTO-SAR-ECO Fittings for twin - castors (2) OTO-SAR-ECO	169
-----------	--	------------



							
GFR0 pg.169	GFRR pg.169	GFRQ pg.169	GGRO pg.169	GPRO pg.170	GLRO pg.170	GLBO pg.170	GPBO pg.170

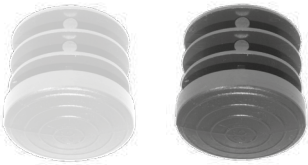
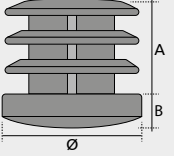

46	Attrezzi Toolings	171
-----------	------------------------------------	------------

	
CER pg.171	pg.171

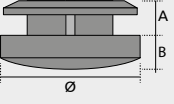
01 | Puntali per interno rotondi | Round tube inserts

		Puntali alettati in PE Ribbed inserts for round tubes in PE				Nero Black			Colorato a richiesta Coloured version on demand		
		Codice Code	Ø	A	B	€	Pz x conf Pcs box-bag	MOQ	€	Pz x conf Pcs box-bag	MOQ
 		11.01.101.02	10	9	5	-	5000	5000	-	-	-
		11.01.102.02	12	10	5	-	5000	5000	-	-	-
		11.01.103.02	14	14	5	-	5000	5000	-	-	-
		11.01.104.02	16	16	5	-	5000	5000	-	-	-
		11.01.105.02	18	13	5	-	5000	5000	-	-	-
		11.01.106.02	20	13	5	-	8000	8000	-	-	-
		11.01.107.02	22	13	5	-	7000	7000	-	-	-
		11.01.108.02	24	20	5	-	4000	4000	-	-	-
		11.01.109.02	25	19	5	-	4000	4000	-	-	-
		11.01.110.02	26	20	5	-	3500	3500	-	-	-
		11.01.111.02	28	19	5	-	3000	3000	-	-	-
		11.01.112.02	30	19	5	-	2000	2000	-	-	-
		11.01.113.02	32	19	5	-	2500	2500	-	-	-
		11.01.114.02	35	20	5	-	2000	2000	-	-	-
		11.01.115.02	38	22	5	-	1500	1500	-	-	-
		11.01.116.02	40	22	5	-	1250	1250	-	-	-
		11.01.118.02	45	30	5	-	1000	1000	-	-	-
		11.01.280.02	48	22	7	-	1000	1000	-	-	-
		11.01.119.02	50	22	5	-	800	800	-	-	-
		11.01.120.02	60	24	5	-	500	500	-	-	-
11.01.281.02	70	33	6	-	250	250	-	-	-		
11.01.122.02	80	33	5	-	200	200	-	-	-		
11.01.137.02	120	37	5	-	75	150	-	-	-		

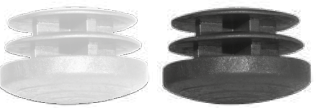
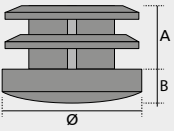
		Puntale ad una aletta in PE One rib insert in PE				Nero Black			Colorato a richiesta Coloured version on demand		
		Codice Code	Ø	A	B	€	Pz x conf Pcs box-bag	MOQ	€	Pz x conf Pcs box-bag	MOQ
 		11.01.265.02	25	6	5	-	5000	10000	-	-	-

		Puntale a due alette in PE Two ribs insert in PE				Nero Black			Colorato a richiesta Coloured version on demand		
		Codice Code	Ø	A	B	€	Pz x conf Pcs box-bag	MOQ	€	Pz x conf Pcs box-bag	MOQ
 		11.01.266.02	25	9	6	-	5000	5000	-	-	-

Puntali alettati in PE e base alta
Ribbed inserts for round tubes in PE high head

IRAP

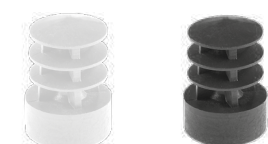
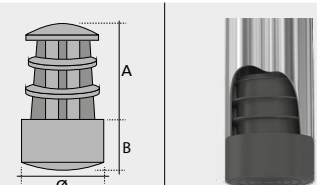
Codice Code	Ø	A	B	Nero Black			Colorato a richiesta Coloured version on demand			
				€	Pz x conf Pcs box-bag	MOQ	€	Pz x conf Pcs box-bag	MOQ	
11.01.131.02	15	17	9	-	3000	3000	-	-	-	
11.01.132.02	16	17	9	-	3000	3000	-	-	-	
11.01.133.02	18	17	9	-	3000	3000	-	-	-	
11.01.135.02	25	20	11	-	2000	2000	-	-	-	

Puntale filetta o senza testa in PP per tubo Ø20
Threaded insert without head in PP for tube Ø20

IRAFS

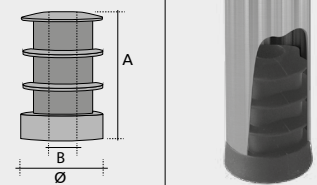
Codice Code	Ø	A	B	Nero Black			
				€	Pz x conf Pcs box-bag	MOQ	
11.01.260.02	18	25	M6	-	5000	10000	
11.01.260.02	18	25	M8	-	5000	10000	

Puntali rotondi alettati e filettati in P
Threaded round inserts in PP

IRAF

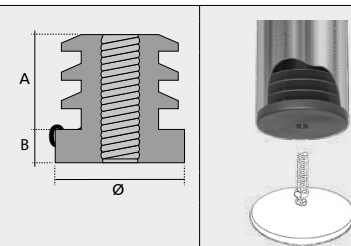
Codice Code	Ø	A	B	Nero M8 Black M8			Nero M10 Black M10			
				€	Pz x conf Pcs box-bag	MOQ	€	Pz x conf Pcs box-bag	MOQ	
11.01.140.02	18	18	6	-	2000	2000	-	2000	2000	
11.01.141.02	20	18	6	-	2000	2000	-	2000	2000	
11.01.142.02	22	19	6	-	1000	1000	-	1000	1000	
11.01.143.02	25	19	6	-	2000	2000	-	2000	2000	
11.01.144.02	28	19	6	-	1000	1000	-	1000	1000	
11.01.152.02	28x2	19	6	-	1000	10000	-	1000	10000	
11.01.145.02	30	19	6	-	1000	1000	-	1000	1000	
11.01.146.02	32	19	6	-	1000	1000	-	1000	1000	
11.01.147.02	35	20	6	-	1000	1000	-	1000	1000	
11.01.148.02	40	20	6	-	1000	1000	-	1000	1000	
11.01.150.02	45	23	6	-	500	2000	-	500	500	
11.01.149.02	50	21	6	-	500	500	-	500	500	
11.01.157.02	60	25	7	-	250	2000	-	250	250	
11.01.151.02	80	31	8	-	200	600	-	200	200	

Misure riferite al Ø esterno del tubo - Da non usare per le rotelle | Sizes referred to external Ø - Not to use with castors

INDEX

IRG

Puntali per ghiera
Round inserts with large base (for ring)

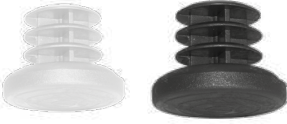
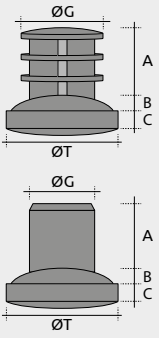
	Codice Code	Øgambo x testa Øfor head leg	A	B	C	Nero Black			Colorato a richiesta Coloured version on demand		
						€	Pz x conf Pcs box-bag	MOQ	€	Pz x conf Pcs box-bag	MOQ
	11.01.191.01	8x18	16	3	5	-	4000	4000	-	-	-
	11.01.192.02	°7-8x18	13	3	5	-	2000	2000	-	-	-
	11.01.193.01	10x20	17	3	5	-	2000	2000	-	-	-
	11.01.194.01	12x24	17	4	5	-	1000	1000	-	-	-
	11.01.195.01	14x28	17	4	5	-	1000	1000	-	-	-
	11.01.196.02	°15-16x26	16	4	5	-	1000	1000	-	-	-
	11.01.197.01	17x32	18	4	5	-	1000	5000	-	-	-
	11.01.198.01	18x32	19	4	6	-	1000	5000	-	-	-
	11.01.199.02	°19-20x34	21	4	5	-	1000	1000	-	-	-
	11.01.201.02	°22-23x36	29	4	6	-	1000	1000	-	-	-

Le misure indicate con (°) sono alettate e in PE. Le altre sono lisce e in PVC | Sizes indicated (°) are ribbed and in Pe. The smooth ones are in PVC

IRGI

Puntale per ghiera inclinato 12° in PE
Round insert with large base in PE inclined 12°

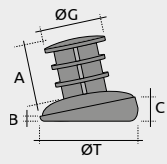
	Codice Code	Misure dimensions	A	B	C	Nero Black			Colorato a richiesta Coloured version on demand		
						€	Pz x conf Pcs box-bag	MOQ	€	Pz x conf Pcs box-bag	MOQ
	11.01.228.02	22-23x36	19	1,5	7,5	-	1000	5000	-	-	-

IRG

Ghiera per puntali
Metal ring for round inserts

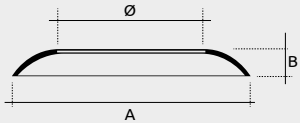
	Codice Code	Misura dimensions	A	B	Cromato Chrome plated		
					€	Pz x conf Pcs box-bag	MOQ
	11.01.211.68	7-8	18	3	-	4000	4000
	11.01.212.68	10	20	3	-	4000	4000
	11.01.213.68	12	24	4	-	2000	6000
	11.01.214.68	14	28	4	-	1000	10000
	11.01.215.68	16	26	4	-	1000	1000
	11.01.216.68	17-18	32	4	-	1000	5000
	11.01.217.68	20	34	4	-	1000	5000
	11.01.218.68	22	36	4	-	1000	5000

Puntale testa larga Ø40 per tubo spes.1 mm.
Wide head insert Ø40 for tube - thickness 1 mm

PTL

Codice Code	Ø	A	B	C	D	Nero Black		
						€	Pz x conf Pcs box-bag	MOQ
11.01.183.02	40	38	49	20	6	-	1250	1250

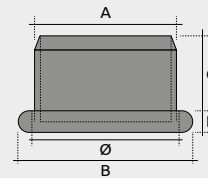
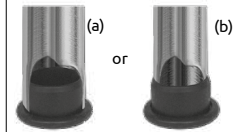

Innesto per tubi rotondi in PS
Tube connectors in PS

ITR

Codice Code	A	B	C	S.T.	Nero Black		
					€	Pz x conf Pcs box-bag	MOQ
11.24.209.76	35	29	8MA	1	-	500	1000
21.24.210.00	40	32	8MA	1	-	100	400
11.24.211.76	50	34	8MA	1	-	600	3000

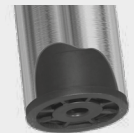
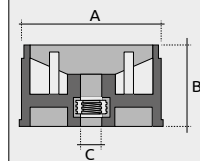

Innesto per tubi rotondi filetta o in PA
Threaded connector for round tube in PA

ITR

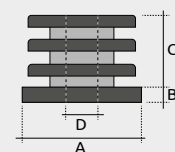

Codice Code	A	B	D	S.T.	Nero Black		
					€	Pz x conf Pcs box-bag	MOQ
11.24.208.05	30	4	8MA	1,2	-	1000	1000



INDEX

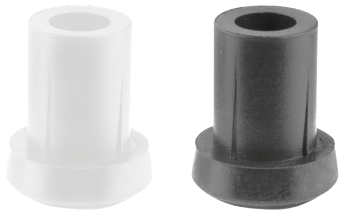
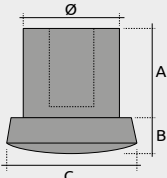

IRN

Puntali o sottopiedi in PVC
Ribbed inserts in PVC

	Codice Code	Ø	A	B	C	Nero Black			Colorato a richiesta Coloured version on demand		
						€	Pz x conf Pcs box-bag	MOQ	€	Pz x conf Pcs box-bag	MOQ
 	11.01.231.01	8	14	5	12	-	10000	10000	-	-	-
	11.01.232.01	9	15	5	13	-	10000	10000	-	-	-
	11.01.233.01	10	14	5	14	-	10000	10000	-	-	-
	11.01.234.01	11	16	6	15	-	5000	10000	-	-	-
	11.01.235.01	12	16	6	16	-	5000	10000	-	-	-
	11.01.236.01	13	16	7	17	-	5000	10000	-	-	-
	11.01.237.01	14	18	7	19	-	4000	10000	-	-	-
	11.01.238.01	15	18	7	20	-	5000	10000	-	-	-
	11.01.239.01	16	19	8	21	-	2000	10000	-	-	-
	11.01.240.01	17	19	8	22	-	2500	10000	-	-	-
	11.01.241.01	18	19	8	23	-	2500	10000	-	-	-
	11.01.242.01	19	19	6	24	-	2500	10000	-	-	-
	11.01.243.01	20	20	7	25	-	2500	10000	-	-	-
	11.01.244.01	21	21	7	25	-	2000	10000	-	-	-
	11.01.245.01	22	20	7	26	-	-	10000	-	-	-
	11.01.246.01	23	20	7	28	-	1000	10000	-	-	-
	11.01.247.01	24	20	7	29	-	1000	10000	-	-	-
	11.01.248.01	25	20	7	29	-	2000	10000	-	-	-
	11.01.249.01	26	20	8	31	-	1000	5000	-	-	-
	11.01.250.01	27	20	8	31	-	1000	5000	-	-	-
11.01.251.01	28	22	9	34	-	1000	5000	-	-	-	
11.01.252.01	29	22	8	34	-	1000	5000	-	-	-	
11.01.256.01	40	25	10	45	-	1000	5000	-	-	-	

IRAI

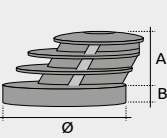
Puntali alettati inclinati 30° in PE
Inclined ribbed inserts 30° in PE

	Codice Code	Ø	A	B	Nero Black			Colorato a richiesta Coloured version on demand		
					€	Pz x conf Pcs box-bag	MOQ	€	Pz x conf Pcs box-bag	MOQ
 	11.01.161.02	16	15	5	-	5000	5000	-	-	-
	11.01.162.02	18	15	5	-	5000	5000	-	-	-
	11.01.164.02	22	18	6	-	5000	5000	-	-	-
	11.01.165.02	25	18	6	-	2500	5000	-	-	-
	11.01.166.02	28	18	6	-	2500	5000	-	-	-
11.01.170.02	60	40	6	-	250	1000	-	-	-	

IRAI

Puntali alettati inclinati 13° in PE
Inclined ribbed inserts 13° in PE

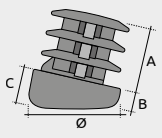
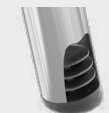
	Codice Code	Ø	A	B	C	Nero Black			Colorato a richiesta Coloured version on demand		
						€	Pz x conf Pcs box-bag	MOQ	€	Pz x conf Pcs box-bag	MOQ
 	21.01.171.00	25	18	5	10	-	2000	4000	-	-	-

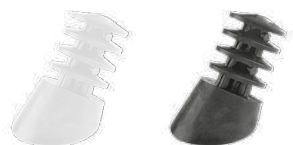
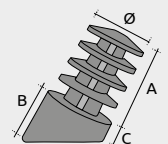
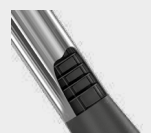

Puntali con zoccolo inclinati 30° in PE
Inserts with inclined base 30° in PE

IRZI

Codice Code	Ø	A	B	C	Nero Black			Colorato a richiesta Coloured version on demand			
					€	Pz x conf Pcs box-bag	MOQ	€	Pz x conf Pcs box-bag	MOQ	
11.01.178.02	18	21	16	5	-	5000	5000	-	-	-	 
11.01.181.02	25	25	23	6	-	2000	2000	-	-	-	

Puntali copritesta, a testa sferica alettati in PE
Spherical round cover tube in PE

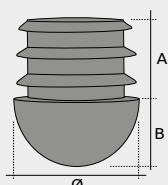
ITSA

Codice Code	ØTesta Øhead	A	B	Nero Black			Colorato a richiesta Coloured version on demand			
				€	Pz x conf Pcs box-bag	MOQ	€	Pz x conf Pcs box-bag	MOQ	
11.01.287.02	16	12	7	-	4000	4000	-	-	-	 
11.01.288.02	18	12	7,5	-	4000	4000	-	-	-	
11.01.289.02	20	15	9,0	-	4000	4000	-	-	-	
11.01.290.02	22	15	10,0	-	4000	4000	-	-	-	
11.01.291.02	25	15	11,0	-	4000	4000	-	-	-	
11.01.292.02	28	16	12,5	-	3000	3000	-	-	-	
11.01.293.02	30	18	13,5	-	2500	2500	-	-	-	
11.01.294.02	32	18	16,5	-	2000	2000	-	-	-	
11.01.295.02	35	20	17,0	-	1500	1500	-	-	-	
11.01.297.02	40	22	19,5	-	1000	1000	-	-	-	
11.01.299.02	60	30	32	-	250	250	-	-	-	

Puntali copritesta-testa sferica alettati in PE per tubo spess. 2 mm
Spherical round cover tube in PE, for tube-thickness 2 mm

ITSA

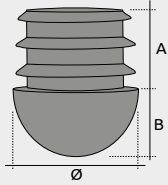
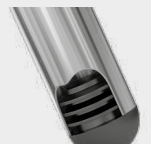
Codice Code	Ø	S.T.	A	B	Nero Black			Colorato a richiesta Coloured version on demand			
					€	Pz x conf Pcs box-bag	MOQ	€	Pz x conf Pcs box-bag	MOQ	
11.01.286.02	14	2.0	10	9	-	5000	10000	-	-	-	 

INDEX

ITSA2

Puntali copritesta, a testa emisferica in PP
Hemispherical round cover tube in PP

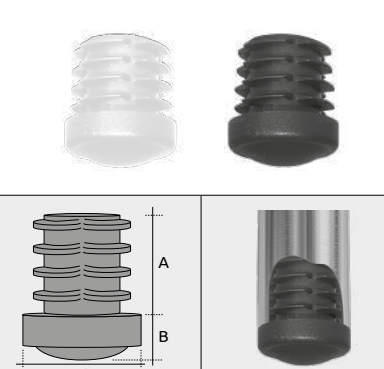
	Codice Code	ØTesta Øhead	A	B	Nero Black			Colorato a richiesta Coloured version on demand		
					€	Pz x conf Pcs box-bag	MOQ	€	Pz x conf Pcs box-bag	MOQ
	11.01.310.02	20	15	7,5	-	4000	4000	-	-	-
	11.01.311.02	22	17	8,5	-	4000	4000	-	-	-
	11.01.312.02	25	18	10	-	4000	4000	-	-	-
	11.01.313.02	30	20	10,5	-	2500	2500	-	-	-

ITLA

Puntali copritesta, a testa liscia in PP
Cover tube with smooth head in PP

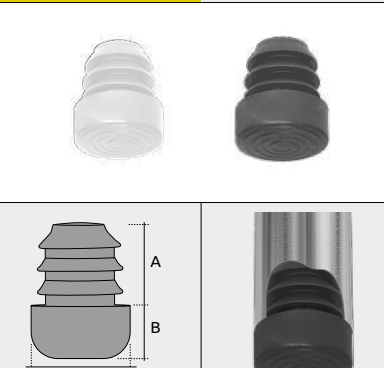
	Codice Code	ØTesta Øhead	A	B	Nero Black			Colorato a richiesta Coloured version on demand		
					€	Pz x conf Pcs box-bag	MOQ	€	Pz x conf Pcs box-bag	MOQ
	11.01.320.02	20	15	7,5	-	4000	4000	-	-	-
	11.01.321.02	22	17	8	-	4000	4000	-	-	-
	11.01.322.02	25	18	9	-	4000	4000	-	-	-
	11.01.323.02	30	20	10	-	2500	2500	-	-	-

IRTA

Puntale testa alta D22 H57.5
High head insert D22 H57.5

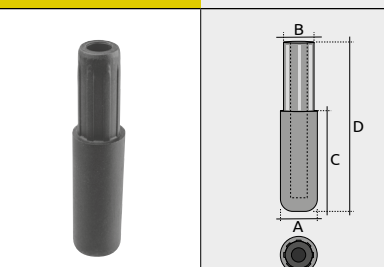
	Codice Code	A	B	C	D	Nero Black			
						€	Pz x conf Pcs box-bag	MOQ	
	11.01.300.05	Ø22	Ø18	57.5	95	-	700	-	
Per tubo spessore 2 mm For tube thickness 2 mm									

IRF

Puntale tondo con feltro
Round tube inserts (with felt pads)

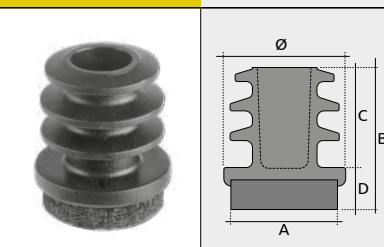
	Codice Code	Ø	A	B	C	D	Nero Black		
							€	Pz x conf Pcs box-bag	MOQ
	21.01.340.00	16	14	24	19	5	-	500	500
	21.01.341.00	18	16	24	19	5	-	500	500
	21.01.342.00	20	18	24	19	5	-	500	500
	21.01.343.00	22	20	24	19	5	-	500	500
	21.01.344.00	25	23	24	19	5	-	500	500

Copritesta alettato in PE Round tube covers in PE										CCR
Codice Code	ØTesta Øhead	A	B	Nero Black			Colorato a richiesta Coloured version on demand			
				€	Pz x conf Pcs box-bag	MOQ	€	Pz x conf Pcs box-bag	MOQ	
11.02.111.02	10	8	2	-	10000	10000	-	-	-	
11.02.112.02	12	8	2	-	10000	10000	-	-	-	
11.02.113.02	14	8	2	-	10000	10000	-	-	-	
11.02.114.02	15	8	3	-	10000	10000	-	-	-	
11.02.115.02	16	9,5	3	-	10000	10000	-	-	-	
11.02.116.02	18	9	3	-	10000	10000	-	-	-	
11.02.117.02	20	9,5	4	-	5000	5000	-	-	-	
11.02.106.02	22	10	4	-	7500	7500	-	-	-	
11.02.107.02	25	13	4	-	4000	4000	-	-	-	
11.02.108.02	28	15	5	-	3000	3000	-	-	-	
11.02.109.02	30	17	5	-	3000	3000	-	-	-	
11.02.090.02	32	16	5	-	2500	2500	-	-	-	
11.02.091.02	35	17	5	-	2000	2000	-	-	-	
11.02.092.02	40	17	3	-	1500	1500	-	-	-	
11.02.093.02	45	17	5	-	1000	1000	-	-	-	
11.02.094.02	50	17	5	-	1000	1000	-	-	-	
11.02.095.02	60	17	5	-	750	750	-	-	-	
11.02.097.02	80	17	6	-	400	400	-	-	-	
11.02.084.02	90	23	7	-	250	250	-	-	-	
11.02.085.02	100	29	6	-	100	100	-	-	-	

Copritesta speciale per vibratore nero
Tube cover specific for vib . in black

CCRA

Codice Code	ØTesta Øhead	A	B	Nero Black			
				€	Pz x conf Pcs box-bag	MOQ	
19.19.113.02	16	10,6	1,4	-	15000	15000	
19.19.114.02	18	10,6	1,4	-	12000	12000	
19.19.115.02	22	11,6	1,7	-	10000	10000	

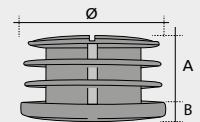

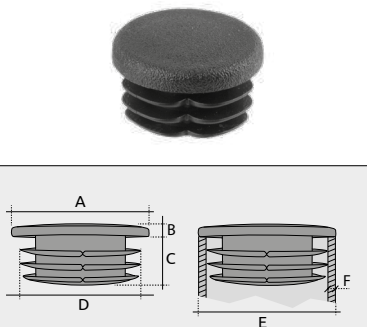
Copritesta alettato rotondo in PE Ribbed round tube cover in PE										CCRN
Codice Code	A	B	C	D	E	F Spessore tubo Tube thickness (mm)	Nero Black			
							€	Pz x conf Pcs box-bag	MOQ	
11.02.361.02	Ø16	4	10	14	16	1-2.5	-	5000	10000	
11.02.362.02	Ø18	4	10	16	18	1-2.5	-	10000	10000	
11.02.363.02	Ø20	4	10	18.5	20	1-3	-	5000	5000	
11.02.364.02	Ø22	4	10	20.5	22	1-3	-	7500	7500	
11.02.365.02	Ø25	4	10	23.5	25	1-3	-	5000	5000	
11.02.366.02	Ø40	4	11	38.5	40	1-3	-	1500	1500	

INDEX

CCRC

Copritesta a un'aletta in PE
One ribbed insert in PE

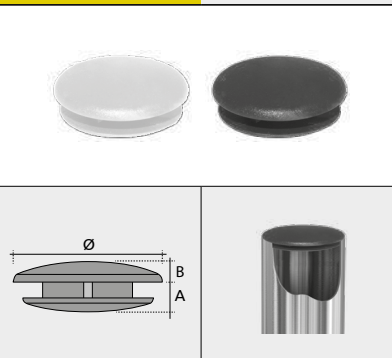
	Codice Code	ØTesta Øhead	A	B	Nero Black			Colorato a richiesta Coloured version on demand		
					€	Pz x conf Pcs box-bag	MOQ	€	Pz x conf Pcs box-bag	MOQ
	11.02.330.02	25	5	3,5	-	5000	5000	-	-	-

CCRL

Copritesta alettato in PE
Ribbed round tube cover in PE

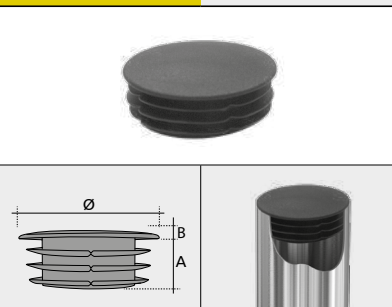
	Codice Code	ØTesta Øhead	A	B	Nero Black		
					€	Pz x conf Pcs box-bag	MOQ
	11.02.350.02	38	12	3,5	-	3000	3000

CTM

Copritesta alettato in PE-testa in FE cromato
Ribbed round tube cover in PE with metal head

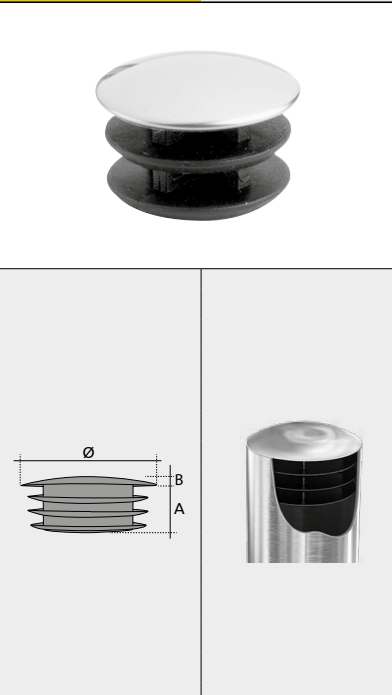
	Codice Code	ØTesta Øhead	A	B	Cromato Chrome plated		
					€	Pz x conf Pcs box-bag	MOQ
	11.02.224.52	13	8	2	-	1000	4000
	11.02.225.52	14	10	2	-	1000	2000
	11.02.226.52	16	10	2	-	1000	2000
	11.02.227.52	18	10	2	-	1000	2000
	11.02.223.52	19	10	2	-	1000	3000
	11.02.228.52	20	10	3	-	1000	3000
	11.02.229.52	22	11	3	-	1000	3000
	11.02.231.52	25	15	3	-	1000	3000
	11.02.230.52	25x1.5	15	3	-	1000	3000
	11.02.232.52	25x1.8	15	3	-	1000	20000
	11.02.238.52	25x2.0	15	3	-	1000	3000
	11.02.269.52	25x4.5	15	3	-	1000	10000
	11.02.233.52	28	15	3	-	500	2000
	11.02.221.52	28.6	15	3	-	500	20000
	11.02.234.52	30	16	3	-	500	2000
	11.02.235.52	32	16	3	-	250	2000
	11.02.236.52	35	16	3	-	250	2000
	11.02.240.52	38	16	3	-	250	1000
	11.02.237.52	40	16	3	-	250	1000
	11.02.239.52	45	16	3	-	250	750

Copritesta in PP con testa in FE cromato
Ribbed round tube cover in PE and metal top

CRM

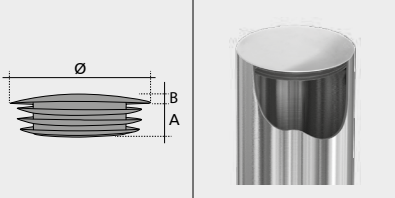
Codice Code	ØT	S.T.	A	B	Cromato Chrome plated			
					€	Pz x conf Pcs box-bag	MOQ	
11.02.245.52	50	1.0	12	3	-	200	600	
11.02.246.52	50	1.2	12	3	-	200	600	
11.02.247.52	50	1.5	12	3	-	200	600	
11.02.248.52	50	2.0	12	3	-	200	1200	
11.02.249.52	60	1.0	16	3	-	200	1000	
11.02.250.52	60	1.2	16	3	-	200	800	
11.02.251.52	60	1.5	16	3	-	200	400	
11.02.252.52	60	2.0	16	3	-	200	400	
11.02.258.52	80	1.2	12	3	-	100	1000	
11.02.259.52	80	1.5	12	3	-	100	1000	

Copritesta alettato in PE con testa sferica in FE cromato
Ribbed round tube cover in PE with round metal head

ITSC

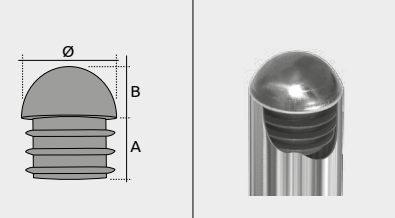
Codice Code	ØTesta Øhead	A	B	Cromato Chrome Plated			
				€	Pz x conf Pcs box-bag	MOQ	
11.02.065.52	25	15	12	-	500	4000	

Copritesta a sfera in PVC
Ball cover in PVC

CS

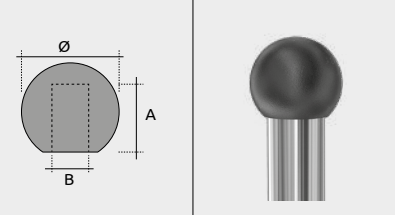
Codice Code	Øsfera Øball	A	B	Nero Black			Colorato a richiesta Coloured version on demand			
				€	Pz x conf Pcs box-bag	MOQ	€	Pz x conf Pcs box-bag	MOQ	
11.02.161.01	10	7	3	-	15000	15000	-	-	-	
11.02.162.01	10	8	4	-	15000	15000	-	-	-	
11.02.163.01	14	12	5	-	15000	15000	-	-	-	

Adatte per terminali filo ferro | Suitable for wires

Copritesta tubi in FE imbutito Round tube cover in metal

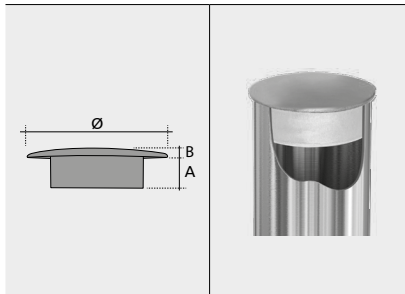

Adatti per turare le estremità dei tubi.
Suitable to close tubes.

Codice Code	ØT	S.T.	A	B	Ferro Grezzo Raw iron		
					€	Pz x conf Pcs box-bag	MOQ
11.02.182.67	16	1,5	7	2	-	1000	5000
11.02.183.67	18	1,5	7	2	-	1000	1000
11.02.184.67	18	1,2	7	2	-	1000	5000
11.02.180.67	18	1,0	7	2	-	1000	5000
11.02.181.67	20	1,5	10	2	-	1000	5000
11.02.185.67	20	1,2	10	2	-	1000	1000
11.02.178.67	20	1,0	10	2	-	1000	5000
11.02.179.67	22	1,5	9	3	-	1000	1000
11.02.186.67	22	1,2	9	3	-	1000	1000
11.02.167.67	22,2	1,15	-	-	-	1000	5000
11.02.188.67	25	1,2	9	3	-	1000	1000
11.02.187.67	25	1,5	9	3	-	1000	1000
11.02.189.67	28	1,5	7	3	-	1000	1000
11.02.195.67	30	2,0	8	3	-	1000	1000
11.02.190.67	30	1,5	8	3	-	1000	1000
11.02.176.67	30	0,85	8	3	-	1000	10000
11.02.191.67	32	2,0	8	3	-	1000	1000
11.02.192.67	32	1,5	8	3	-	1000	1000
11.02.193.67	32	1,2	8	3	-	1000	5000
11.02.194.67	32	1,0	8	3	-	1000	5000
11.02.196.67	35	1,5	9	3	-	500	500
11.02.197.67	35	1,2	9	3	-	500	500
11.02.198.67	35	1,0	9	3	-	500	5000
11.02.199.67	40	1,0	9	4	-	500	5000
11.02.166.67	40	1,5	9	4	-	500	500

Codice Code	ØT	S.T.	A	B	Nero Black			Cromato Metallizzato Chromed plated Brass metallized		
					€	Pz x conf Pcs box-bag	MOQ	€	Pz x conf Pcs box-bag	MOQ
21.02.125.00	8	1	4,5	1,5	-	1000	6000	-	1000	6000
21.02.126.00	10	1	5	2	-	1000	6000	-	1000	6000
21.02.127.00	12	1	5	2	-	1000	5000	-	1000	5000
21.02.309.00	13	1	6	2	-	1000	5000	-	1000	5000
21.02.128.00	14	1	8	3	-	1000	5000	-	1000	5000
21.02.129.00	16	1	8	3	-	1000	2000	-	1000	2000
21.02.203.00	16	1,2	8	3	-	1000	2000	-	1000	2000
21.02.217.00	16	1,5	8	3	-	1000	2000	-	1000	2000
21.02.132.00	18	1	8	3	-	1000	2000	-	1000	2000
21.02.131.00	18	1,2	8	3	-	1000	2000	-	1000	2000
21.02.130.00	18	1,5	8	4	-	1000	2000	-	1000	2000
21.02.220.00	19	1,2	9	4	-	1000	2000	-	1000	2000
21.02.241.00	19	1,5	9	5	-	1000	2000	-	1000	2000
21.02.135.00	20	1	8	5	-	1000	2000	-	1000	2000
21.02.134.00	20	1,2	8	5	-	1000	2000	-	1000	2000
21.02.133.00	20	1,5	8	5	-	1000	2000	-	1000	2000
21.02.138.00	22	1	8	5	-	500	1000	-	500	1000
21.02.137.00	22	1,2	8	5	-	500	1000	-	500	1000
21.02.136.00	22	1,5	8	5	-	500	1000	-	500	1000
21.02.244.00	22	2	8	5	-	500	1000	-	500	1000
21.02.142.00	25	1	8	5	-	500	1000	-	500	1000
21.02.141.00	25	1,2	8	5	-	500	1000	-	500	1000
21.02.140.00	25	1,5	8	5	-	500	1000	-	500	1000
21.02.139.00	25	2	8	5	-	500	1000	-	500	1000
21.02.209.00	25.4	1,25	8	5	-	500	1000	-	500	1000
21.02.146.00	28	1	10	5	-	250	500	-	250	500
21.02.145.00	28	1,2	10	5	-	250	500	-	250	500
21.02.144.00	28	1,5	10	5	-	250	500	-	250	500
21.02.143.00	28	2	10	5	-	250	500	-	250	500
21.02.150.00	30	1	10	5	-	250	500	-	250	500
21.02.149.00	30	1,2	10	5	-	250	500	-	250	500
21.02.148.00	30	1,5	10	5	-	250	500	-	250	500
21.02.147.00	30	2	10	5	-	250	500	-	250	500
21.02.211.00	32	1,2	10	5	-	250	500	-	250	500
21.02.210.00	32	1,5	10	5	-	250	500	-	250	500
21.02.291.00	32	2	10	5	-	250	500	-	250	500
21.02.310.00	32	3	10	5	-	250	500	-	250	500
21.02.292.00	35	1	10	5	-	200	600	-	200	600
21.02.156.00	35	1,2	10	5	-	200	600	-	200	600
21.02.158.00	35	1,5	10	5	-	200	600	-	200	600
21.02.293.00	35	2	10	8	-	200	600	-	200	600
21.02.152.00	38	1,5	10	3	-	200	400	-	200	400
21.02.151.00	38	2	10	3	-	200	400	-	200	400
21.02.296.00	40	1	10	3	-	200	400	-	200	400
21.02.159.00	40	1,5	10	3	-	200	400	-	200	400
21.02.153.00	40	2	10	3	-	200	400	-	200	400
21.02.311.00	45	1,5	11	4	-	200	200	-	200	200
21.02.312.00	45	2	11	4	-	200	200	-	200	200
21.02.154.00	50	1	11	5	-	200	200	-	200	200
21.02.160.00	50	1,2	11	5	-	200	200	-	200	200
21.02.157.00	50	1,5	11	5	-	200	200	-	200	200
21.02.298.00	50	2	11	5	-	200	200	-	200	200
21.02.155.00	60	1	11	5	-	100	200	-	100	200
21.02.201.00	60	1,2	11	5	-	100	200	-	100	200
21.02.202.00	60	1,5	11	5	-	100	200	-	100	200
21.02.205.00	70	1,2	11	5	-	100	200	-	100	200
21.02.204.00	70	1,5	11	5	-	100	200	-	100	200
21.02.206.00	80	1,2	11	5	-	100	100	-	100	100
21.02.200.00	80	1,5	11	5	-	100	100	-	100	100
21.02.208.00	90	1,2	11	5	-	50	100	-	50	100
21.02.207.00	90	1,5	11	5	-	50	100	-	50	100
21.02.124.00	120	5	16	8	-	25	25	-	25	25

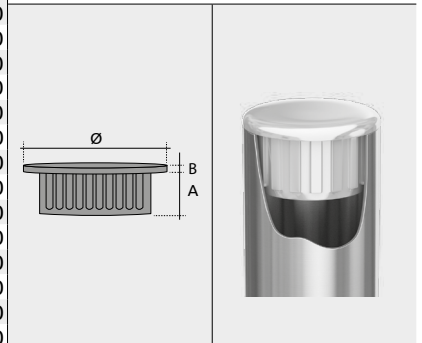

03 | Puntali quadri | Square tube inserts

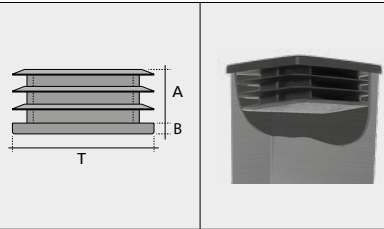
		Puntale quadro alettato in PE Square insert in PE				Nero Black			Colorato a richiesta Coloured version on demand		
		Codice Code	Testa Head	A	B	€	Pz x conf Pcs box-bag	MOQ	€	Pz x conf Pcs box-bag	MOQ
		11.03.121.02	12x12	12	5	-	3000	3000	-	-	-
		11.03.122.02	15x15	11	4	-	2500	2500	-	-	-
		11.03.123.02	16x16	17	5	-	2500	2500	-	-	-
		11.03.124.02	18x18	12	5	-	2500	2500	-	-	-
		11.03.125.02	20x20	17	5	-	5000	5000	-	-	-
		11.03.126.02	22x22	17	5	-	2000	2000	-	-	-
		11.03.127.02	25x25	17	5	-	2500	2500	-	-	-
		11.03.128.02	30x30	19	5	-	2000	2000	-	-	-
		11.03.129.02	35x35	18	6	-	1000	1000	-	-	-
		11.03.130.02	40x40	18	6	-	1000	1000	-	-	-
		11.03.131.02	50x50	22	6	-	600	600	-	-	-
		11.03.132.02	60x60	24	6	-	500	500	-	-	-
		11.03.134.02	70x70	25	6	-	300	300	-	-	-
		11.03.137.02	80x80	30	6	-	150	150	-	-	-
		11.03.138.02	100x100	30	6	-	100	100	-	-	-

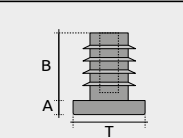
		Puntale quadro alettato in PE per tubo 2 mm Square insert in PE for tube 2 mm				Nero Black			Colorato a richiesta Coloured version on demand		
		Codice Code	Testa Head	A	B	€	Pz x conf Pcs box-bag	MOQ	€	Pz x conf Pcs box-bag	MOQ
		11.03.145.02	15x15	14	8	-	5000	10000	-	-	-

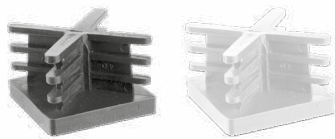
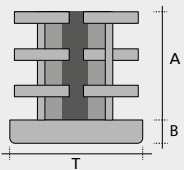
		Puntali quadri alettati in PE-Alettatura a croce Square inserts in PE				Nero Black			Colorato a richiesta Coloured version on demand		
		Codice Code	Testa Head	A	B	€	Pz x conf Pcs box-bag	MOQ	€	Pz x conf Pcs box-bag	MOQ
		11.03.148.02	15x15	11	4	-	2500	10000	-	-	-
		11.03.140.02	25x25	20	6	-	2000	10000	-	-	-
		11.03.147.02	30x30	21	6	-	2000	10000	-	-	-
		11.03.135.02	32x32	21	6	-	1000	5000	-	-	-
		11.03.119.02	35x35	21	6	-	1000	5000	-	-	-
		11.03.150.02	40x40	21	6	-	1000	1000	-	-	-
		11.03.133.02	45x45	21	5	-	500	500	-	-	-
		11.03.142.02	50x50	21	6	-	600	600	-	-	-
		11.03.141.02	60x60	22	6	-	450	4500	-	-	-

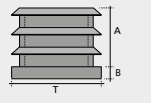
		Puntali quadri alettati in PE Square insert in PE				Nero Black			Colorato a richiesta Coloured version on demand			
		Codice Code	Testa Head	S.T.	A	B	€	Pz x conf Pcs box-bag	MOQ	€	Pz x conf Pcs box-bag	MOQ
		11.03.270.02	30x30	1	17	5,5	-	2000	2000	-	-	-
		11.03.271.02	30x30	1	17	7,5	-	2000	10000	-	-	-

Puntali quadri alettati inclinati 30° in PE
Inclined square inserts 30° in PE

QAI

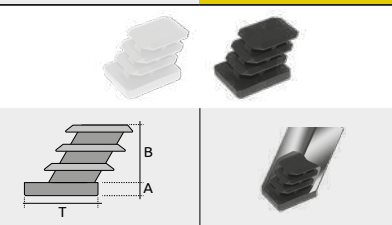
Codice Code	Per tubo For tube	A	B	Nero Black			Colorato a richiesta Coloured version on demand			
				€	Pz x conf Pcs box-bag	MOQ	€	Pz x conf Pcs box-bag	MOQ	
11.03.166.02	20x20	6	19	-	1000	5000	-	-	-	
11.03.167.02	25x25	6	18	-	1000	1000	-	-	-	
11.03.168.02	30x30	6	20	-	1000	1000	-	-	-	

Puntali quadri in PVC
Square inserts in PVC

QI

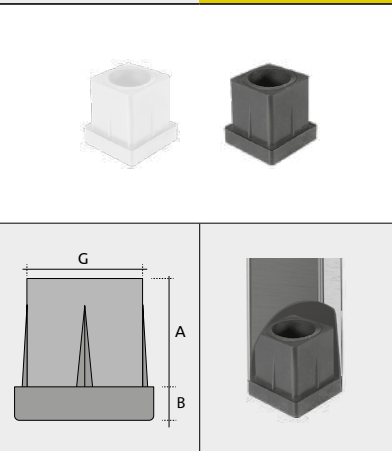
Codice Code	Per tubo For tube	A	B	Nero Black			Colorato a richiesta Coloured version on demand			
				€	Pz x conf Pcs box-bag	MOQ	€	Pz x conf Pcs box-bag	MOQ	
11.03.101.01	12x12	19	6	-	-	10000	-	-	-	
11.03.102.01	13x13	20	6	-	2500	10000	-	-	-	
11.03.103.01	14x14	20	6	-	-	10000	-	-	-	
11.03.104.01	15x15	20	6	-	-	10000	-	-	-	
11.03.105.01	16x16	20	6	-	2500	5000	-	-	-	
11.03.106.01	17x17	20	6	-	1000	5000	-	-	-	
11.03.107.01	18x18	20	6	-	-	5000	-	-	-	
11.03.108.01	19x19	20	6	-	-	5000	-	-	-	
11.03.109.01	20x20	20	6	-	-	5000	-	-	-	
11.03.110.01	21x21	20	6	-	-	5000	-	-	-	
11.03.111.01	22x22	20	6	-	-	5000	-	-	-	

Puntale quadro inclinato 10° alettato a zoccolo in PE
Inclined ribbed square insert 10° in PE

QIZ

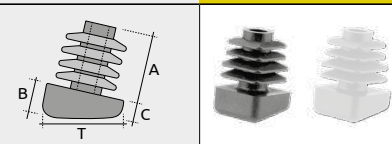
Codice Code	Per tubo For tube	A	B	C	Nero Black			Colorato a richiesta Coloured version on demand			
					€	Pz x conf Pcs box-bag	MOQ	€	Pz x conf Pcs box-bag	MOQ	
11.03.170.02	15x15	15	7	5	-	5000	5000	-	-	-	

Puntali quadrati filettati e alettati in P
Threaded square ribbed insert in PP

QAF

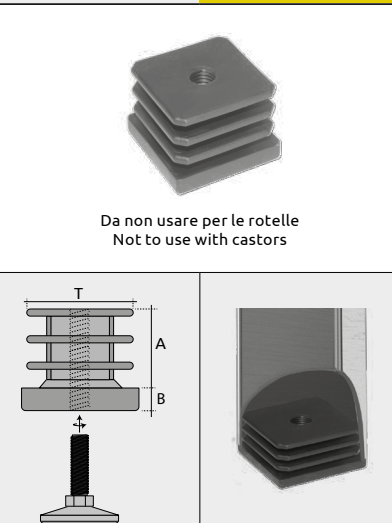
Codice Code	Testa Head	A	B	Nero Black-fi . M8 Screw thread M8 Non usare per le rotelle Not to use with castors			Nero Black-fi . M10 Screw thread M10 Non usare per le rotelle Not to use with castors			 <p>Da non usare per le rotelle Not to use with castors</p>
				€	Pz x conf Pcs box-bag	MOQ	€	Pz x conf Pcs box-bag	MOQ	
11.03.151.02	15x15	18	5	-	1000	5000	/	/	/	
11.03.152.02	16x16	18	5	-	1000	5000	-	1000	5000	
11.03.153.02	18x18	18	5	-	1000	5000	-	1000	5000	
11.03.154.02	20x20	18	5	-	1000	1000	-	1000	1000	
11.03.155.02	22x22	18	5	-	1000	5000	-	1000	5000	
11.03.156.02	25x25	19	5	-	1000	1000	-	1000	1000	
11.03.157.02	30x30	20	6	-	1000	1000	-	1000	1000	
11.03.158.02	35x35	21	6	-	500	500	-	500	500	
11.03.159.02	40x40	22	6	-	500	500	-	500	500	
11.03.160.02	50x50	30	7	-	250	250	-	250	250	
11.03.163.02	60x60	25	7	-	250	1000	-	250	250	
11.03.162.02	80x80	30	8	-	250	1000	-	250	250	



QAFI

Puntali quadrati alettati in PA con inserto filetta o
Threaded square ribbed in PA with iron insert

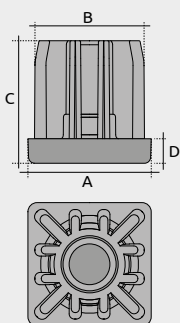
NEW



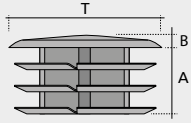

Codice Code	Testa Head	Spessore tubo	Filetto	A	B	C	D	Nero Black		
								€	Pz x conf Pcs box-bag	MOQ
11.03.318.77	25x25	1.5	M8	25	22	25	6	-	1000	1000
11.03.322.77	25x25	1.5	M10	25	22	25	6	-	1000	1000
11.03.326.77	25x25	2	M8	25	21	25	6	-	-	-
11.03.330.77	25x25	2	M10	25	21	25	6	-	-	-
11.03.319.77	30x30	1.5	M8	30	27	30	6	-	500	500
11.03.323.77	30x30	1.5	M10	30	27	30	6	-	500	500
11.03.327.77	30x30	2	M8	30	26	30	6	-	-	-
11.03.331.77	30x30	2	M10	30	26	30	6	-	-	-
11.03.320.77	40x40	1.5	M8	40	37	37	7,5	-	-	-
11.03.324.77	40x40	1.5	M10	40	37	37	7,5	-	-	-
11.03.336.77	40x40	1.5	M12	40	37	37	7,5	-	-	-
11.03.328.77	40x40	2	M8	40	36	37	7,5	-	250	250
11.03.332.77	40x40	2	M10	40	36	37	7,5	-	250	250
11.03.338.77	40x40	2	M12	40	36	37	7,5	-	250	250
11.03.321.77	50x50	1.5	M8	50	47	43	8,5	-	-	-
11.03.325.77	50x50	1.5	M10	50	47	43	8,5	-	-	-
11.03.337.77	50x50	1.5	M12	50	47	43	8,5	-	-	-
11.03.329.77	50x50	2	M8	50	46	43	8,5	-	150	150
11.03.333.77	50x50	2	M10	50	46	43	8,5	-	150	150
11.03.339.77	50x50	2	M12	50	46	43	8,5	-	150	150

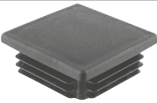
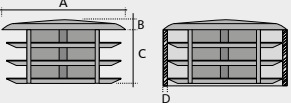
Copritesta quadri in PE Square tube covers in PE										CQI
Codice Code	Testa Head	A	B	Nero Black			Colorato a richiesta Coloured version on demand			
				€	Pz x conf Pcs box-bag	MOQ	€	Pz x conf Pcs box-bag	MOQ	
11.03.174.02	12x12	9	3	-	5000	5000	-	-	-	 
11.03.175.02	14x14	10	3	-	5000	5000	-	-	-	
11.03.173.02	15x15	11	3	-	5000	5000	-	-	-	
11.03.176.02	16x16	10	3	-	5000	5000	-	-	-	
11.03.177.02	18x18	10	3	-	5000	5000	-	-	-	
11.03.178.02	20x20	11	4	-	4000	4000	-	-	-	
11.03.179.02	25x25	15	5	-	3000	3000	-	-	-	
11.03.180.02	30x30	15	5	-	2000	2000	-	-	-	
11.03.181.02	35x35	15	5	-	1500	1500	-	-	-	
11.03.182.02	40x40	16	5	-	1500	1500	-	-	-	
11.03.183.02	50x50	20	5	-	750	750	-	-	-	
11.03.184.02	60x60	24	7	-	400	400	-	-	-	

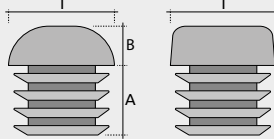
Copritesta quadri in PE Square tube covers in PE										CQIN
Codice Code	Testa Head	A	B	C	D Spessore tubo Tube thickness (mm)	Nero Black				
						€	Pz x conf Pcs box-bag	MOQ		
11.03.279.02	25x25	25	4	10.5	1-3	-	3000	3000		
11.03.280.02	30x30	30	4	12	1-3	-	4000	4000		
11.03.282.02	40x40	40	4	12	1-3	-	1500	1500		
11.03.283.02	50x50	50	5	13	1-3	-	500	500		

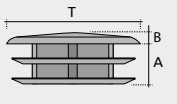
Puntale-Copritesta quadro con testa tonda Square cover cap with round top										ITSQ
Codice Code	Testa Head	A	B	Nero Black			Colorato a richiesta Coloured version on demand			
				€	Pz x conf Pcs box-bag	MOQ	€	Pz x conf Pcs box-bag	MOQ	
11.03.261.02	15x15	15	8	-	5000	5000	-	-	-	
11.03.262.02	18x18	16	8	-	5000	10000	-	-	-	
11.03.263.02	20x20	19	9	-	4000	4000	-	-	-	
11.03.264.02	22x22	18	11	-	2500	2500	-	-	-	
11.03.265.02	25x25	19	12	-	2000	2000	-	-	-	

Copritesta in PE con testa in FE cromato Square tube covers in PE with metal top										CQM
Codice Code	Testa Head	A	B	Cromato Chrome plated						
				€	Pz x conf Pcs box-bag	MOQ				
11.03.243.52	16x16	9	2	-	1000	1000	 			
11.03.244.52	18x18	9	2	-	1000	1000				
11.03.245.52	20x20	10	2	-	1000	1000				
11.03.246.52	25x25	10	2	-	500	1000				
11.03.247.52	30x30	10	3	-	500	1000				
11.03.248.52	35x35	12	3	-	250	1000				
11.03.249.52	40x40	12	3	-	250	1000				

INDEX

CGQ

Copritesta quadri in ABS
Square tube covers in ABS

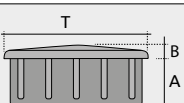
	Codice Code	Testa Head	S.T.	A	B	Nero Black			Cromato Chrome plated		
						€	Pz x conf Pcs box-bag	MOQ	€	Pz x conf Pcs box-bag	MOQ
	21.03.196.00	12x12	1	7	2	-	1000	3000	-	1000	3000
	21.03.197.00	12x12	1.2	7	2	-	1000	3000	-	1000	3000

CGQ

Copritesta galvanizzati quadri in ABS
Square tube covers in ABS

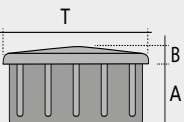
	Codice Code	Testa Head	S.T.	A	B	Nero Black			Cromato Chrome plated		
						€	Pz x conf Pcs box-bag	MOQ	€	Pz x conf Pcs box-bag	MOQ
	21.03.198.00	15x15	1	8,5	2,5	-	1000	2000	-	1000	2000
	21.03.202.00	15x15	1,2	8,5	2,5	-	1000	2000	-	1000	2000
	21.03.205.00	15x15	1,5	8,5	2,5	-	1000	2000	-	1000	2000
	21.03.207.00	16x16	1	8	3	-	1000	2000	-	1000	2000
	21.03.199.00	16x16	1,5	8	3	-	1000	2000	-	1000	2000
	21.03.191.00	18x18	1,2	8	3	-	500	2000	-	500	2000
	21.03.192.00	18x18	1,5	8	3	-	500	2000	-	500	2000
	21.03.212.00	20x20	1	7	3	-	500	1500	-	500	1500
	21.03.213.00	20x20	1,2	7	3	-	500	1500	-	500	1500
	21.03.193.00	20x20	1,5	7	3	-	500	1500	-	500	1500
	21.03.215.00	25x25	1	7	3	-	250	1000	-	250	1000
	21.03.216.00	25x25	1,2	7	3	-	250	1000	-	250	1000
	21.03.194.00	25x25	1,5	7	3	-	250	1000	-	250	1000
	21.03.217.00	25x25	2	7	3	-	250	1000	-	250	1000
	21.03.218.00	30x30	1	10	4	-	200	1000	-	200	1000
	21.03.219.00	30x30	1,2	10	4	-	200	1000	-	200	1000
	21.03.195.00	30x30	1,5	10	4	-	200	1000	-	200	1000
	21.03.222.00	35x35	1,2	11	4	-	200	600	-	200	600
	21.03.200.00	35x35	1,5	11	4	-	200	600	-	200	600
	21.03.225.00	40x40	1,2	11	4	-	100	200	-	100	200
21.03.201.00	40x40	1,5	11	4	-	100	200	-	100	200	
21.03.189.00	45x45	1,2	11	5	-	100	100	-	100	100	
21.03.190.00	45x45	1,5	11	5	-	100	100	-	100	100	
21.03.228.00	50x50	1,2	11	5	-	100	100	-	100	100	
21.03.229.00	50x50	1,5	11	5	-	100	100	-	100	100	
21.03.232.00	60x60	1,2	12	5	-	100	100	-	100	100	
21.03.233.00	60x60	1,5	12	5	-	100	100	-	100	100	
21.03.236.00	80x80	1,2	12	5	-	50	200	-	50	200	
21.03.237.00	80x80	1,5	12	5	-	50	200	-	50	200	
21.03.238.00	80x80	2	12	5	-	50	200	-	50	200	

QIAF

Puntali quadri alettati inclinati 30° in PE
Inclined square inserts 30° in PE

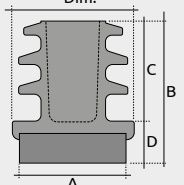
Dim.	Codice Code	Dim.	A	B	C	D	Nero Black		
							€	Pz x conf Pcs box-bag	MOQ
	21.03.300.00	15 x 15	13,5 x 13,5	24	19	5	-	500	500
	21.03.301.00	16 x 16	13,5 x 13,5	24	19	5	-	500	500
	21.03.302.00	20 x 20	17,5 x 17,5	24	19	5	-	500	500
	21.03.303.00	25 x 25	22,5 x 22,5	24	19	5	-	500	500

Puntali rettangolari alettati in PE
Rectangular ribbed insert in PE

RIA

Codice Code	Testa Head	A	B	Nero Black			Colorato a richiesta Coloured version on demand		
				€	Pz x conf Pcs box-bag	MOQ	€	Pz x conf Pcs box-bag	MOQ
11.04.100.02	10x15	11	5	-	3000	3000	-	-	-
11.04.101.02	10x20	15	5	-	3000	3000	-	-	-
11.04.102.02	10x25	15	5	-	2500	2500	-	-	-
11.04.103.02	10x30	15	5	-	2500	2500	-	-	-
11.04.098.02	10x35	16.5	5	-	2000	10000	-	-	-
11.04.099.02	10x50	17	5	-	2000	2000	-	-	-
11.04.115.02	10x40	15	5	-	2000	2000	-	-	-
11.04.104.02	15x20	12	5	-	2000	2000	-	-	-
11.04.105.02	15x25	17	5	-	2000	2000	-	-	-
11.04.106.02	15x30	12	5	-	5000	5000	-	-	-
11.04.107.02	15x35	18	6	-	1500	1500	-	-	-
11.04.108.02	15x40	18	6	-	1000	1000	-	-	-
11.04.123.02	15x50	15	5	-	1000	1000	-	-	-
11.04.283.02	15x60	17	5	-	1000	1000	-	-	-
11.04.121.02	20x25	12	5	-	2000	6000	-	-	-
11.04.109.02	20x30	17	5	-	2500	2500	-	-	-
11.04.110.02	20x35	17	5	-	2500	2500	-	-	-
11.04.111.02	20x40	17	5	-	2500	2500	-	-	-
11.04.112.02	20x50	17	5	-	1500	1500	-	-	-
11.04.113.02	20x60	17	5	-	1000	1000	-	-	-
11.04.282.02	20x100	23	6	-	750	750	-	-	-
11.04.285.02	25x30	17	5	-	3000	6000	-	-	-
11.04.114.02	25x35	19	6	-	1000	1000	-	-	-
11.04.118.02	25x40	18	6	-	1000	1000	-	-	-
11.04.116.02	25x50	21	6	-	1250	1250	-	-	-
11.04.120.02	30x40	18	6	-	1000	1000	-	-	-
11.04.126.02	30x45	18	6	-	1000	3000	-	-	-
11.04.117.02	30x50	18	6	-	1000	1000	-	-	-
11.04.119.02	30x60	21	6	-	1000	1000	-	-	-
11.04.280.02	30x70	17	6	-	750	750	-	-	-
11.04.281.02	30x80	17	6	-	750	750	-	-	-
11.04.127.02	40x60	17	6	-	750	750	-	-	-
11.04.284.02	40x70	18	6	-	500	500	-	-	-
11.04.122.02	40x80	23	6	-	450	450	-	-	-
11.04.128.02	40x100	23	6	-	400	400	-	-	-
11.04.129.02	50x100	23	6	-	300	300	-	-	-
11.04.287.02	60x80	22	6	-	200	200	-	-	-
11.04.286.02	60x120	22	6	-	200	200	-	-	-

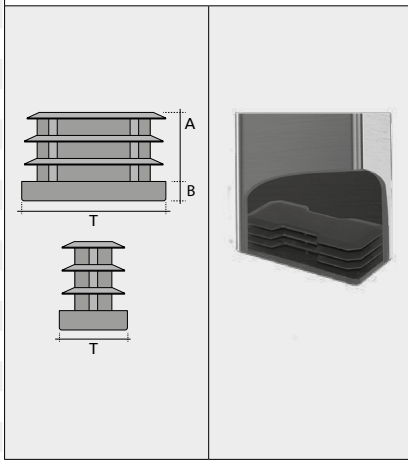

INDEX

CRI

Copritesta-puntali rettangolari alettati in PE
Ribbed rectangular inserts in PE

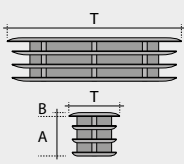
	Codice Code	Testa Head	A	B	Nero Black			Colorato a richiesta Coloured version on demand		
					€	Pz x conf Pcs box-bag	MOQ	€	Pz x conf Pcs box-bag	MOQ
	11.04.145.02	20x80	16	3	-	1000	1000	-	-	-
	11.04.146.02	25x100	15	3	-	600	600	-	-	-
	11.04.147.02	30x100	16	3	-	500	500	-	-	-
	11.04.150.02	20x120	19	5,5	-	500	500	-	-	-

RAI

Puntali rettangolari alettati inclinati in PE
Inclined ribbed rectangular inserts in PE

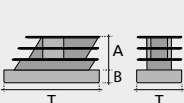
	Codice Code	Testa Head	Inclin Inclinat	A	B	Nero Black			Colorato a richiesta Coloured version on demand		
						€	Pz x conf Pcs box-bag	MOQ	€	Pz x conf Pcs box-bag	MOQ
	11.04.184.02	15x30	15°	17	5	-	4000	4000	-	-	-
	11.04.183.02	20x30	20°	18	6	-	2500	5000	-	-	-
	11.04.181.02	15x30	30°	18	6	-	2500	5000	-	-	-
	11.04.182.02	20x40	30°	19	6	-	1700	3400	-	-	-

RIZ

Puntali rett. inclinato 30° alettati a zoccolo in PE
Inclined ribbed rectangular inserts 30° in PE

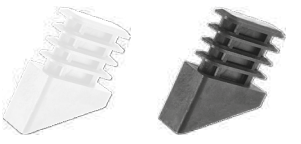
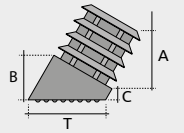
	Codice Code	Testa Head	A	B	C	Nero Black			Colorato a richiesta Coloured version on demand		
						€	Pz x conf Pcs box-bag	MOQ	€	Pz x conf Pcs box-bag	MOQ
	11.04.190.02	15x30	22	22	5	-	2500	5000	-	-	-

RIAS

Puntale rettangolare sagomato in PE
Rectangular shaped inserts in PE

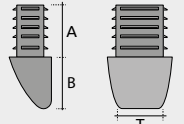
	Codice Code	Testa Head	A	B	Nero Black		
					€	Pz x conf Pcs box-bag	MOQ
	11.04.270.02	30x20	25	25	-	1000	1000

Puntali rettangolari alettati e filettati in P
Rectangular threaded and ribbed insert in PP

RAF

Codice Code	Testa Head	A	B	Nero M8 Black M8			Nero M10 Black M10		
				€	Pz x conf Pcs box-bag	MOQ	€	Pz x conf Pcs box-bag	MOQ
11.04.165.02	20x30	19	6	-	1000	3000	-	1000	1000
11.04.166.02	20x35	19	6	-	1000	5000	-	1000	5000
11.04.167.02	20x40	19	6	-	1000	1000	-	1000	1000
11.04.168.02	20x50	19	6	-	500	5000	-	500	500
11.04.169.02	20x60	19	6	-	500	3000	-	500	1000
11.04.170.02	25x50	22	6	-	500	500	-	500	500
11.04.172.02	30x50	22	6	/	/	/	-	500	1000
11.04.171.02	30x60	22	6	-	500	3000	-	500	3000

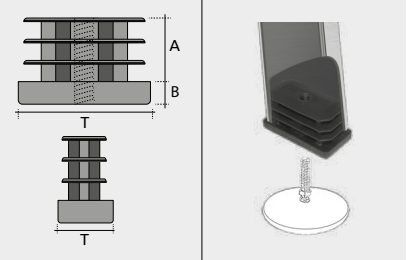
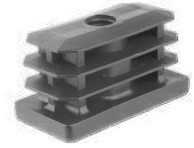

Filetto M8 - M10
Misure riferite all'esterno del tubo - Da non usare per le rotelle
Thread M8 - M10
Sizes referred to external tube - Not to use with castors



Puntali rettangolari in PP-inserito filetta o in ferro
Rectangular inserts in PP with iron thread

RAFI

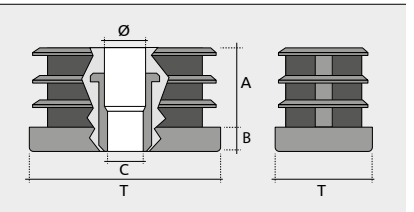
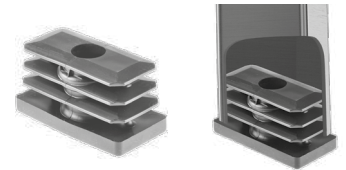
Codice Code	Testa Head	A	B	C	Ø	Nero Black		
						€	Pz x conf Pcs box-bag	MOQ
11.04.250.73	25x50	22	6	M10	11	-	500	500



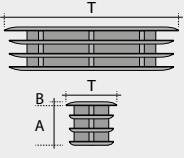

06 | Copritesta rettangolari | Rectangular tube covers

CRI	Copritesta rettangolari alettati in PE Rectangular tube cover inserts in PE									
	Codice Code	Testa Head	A	B	Nero Black			Colorato a richiesta Coloured version on demand		
					€	Pz x conf Pcs box-bag	MOQ	€	Pz x conf Pcs box-bag	MOQ
  	11.04.130.02	10x15	9	3,0	-	4000	4000	-	-	-
	11.04.131.02	10x20	9	3,0	-	4000	4000	-	-	-
	11.04.144.02	10x30	9	3,0	-	2500	2500	-	-	-
	11.04.132.02	10x40	10	3,0	-	2500	2500	-	-	-
	11.04.134.02	15x20	10	3,5	-	3000	3000	-	-	-
	11.04.133.02	15x25	10	3,5	-	3000	3000	-	-	-
	11.04.135.02	15x30	10	3,5	-	3000	3000	-	-	-
	11.04.136.02	15x35	10	3,5	-	2500	2500	-	-	-
	11.04.137.02	15x40	10	3,5	-	2000	2000	-	-	-
	11.04.138.02	20x30	10	4,0	-	4000	4000	-	-	-
	11.04.139.02	20x35	10	4,0	-	4000	4000	-	-	-
	11.04.140.02	20x40	11	4,0	-	2000	2000	-	-	-
	11.04.145.02	20x80 (*)	16	3,0	-	1000	1000	-	-	-
	11.04.143.02	25x40	12	4,0	-	2000	2000	-	-	-
	11.04.141.02	25x50	12	4,0	-	1500	1500	-	-	-
11.04.146.02	25x100 (*)	15	3,0	-	600	600	-	-	-	
11.04.148.02	30x40	13	5,0	-	1500	1500	-	-	-	
11.04.142.02	30x50	13	5,0	-	1500	1500	-	-	-	
11.04.149.02	30x60	19	5,0	-	1200	1200	-	-	-	
11.04.147.02	30x100 (*)	16	3,0	-	500	500	-	-	-	
11.04.150.02	20x120 (*)	19	5,5	-	500	500	-	-	-	

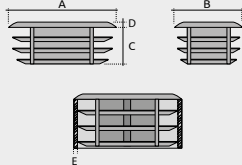
(*) Le misure indicate sono con testa piana e possono essere usate come puntali. These items have flat head and can be used as inserts

CRIN	Copritesta rettangolare Rectangular tube cover inserts									
	Codice Code	A	B	C	D	E	Nero Black			
							€	Pz x conf Pcs box-bag	MOQ	
 	11.04.300.02	40	50	15	4	1-3	-	1000	1000	
	11.04.301.02	60	100	16	5	1-3	-	200	1000	
	11.04.302.02*	30	120	13	4	1-3	-	500	1000	

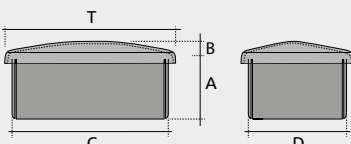
CRIE	Copritesta in PP estetici rettangolari Rectangular cover tube in PP									
	Codice Code	Testa Head	A	B	C	D	Nero Black			
							€	Pz x conf Pcs box-bag	MOQ	
  	11.04.156.02	40x80	15	11	76	36	-	500	500	

INDEX

Copritesta destro e sinistro per stagge Left and right tube cover for levelling staves

CRIS

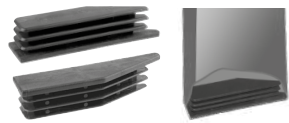
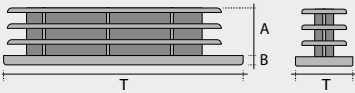
Codice Code	Testa Head	A	B	Nero Black			
				€	Pz x conf Pcs box-bag	MOQ	
11.04.176.02 Destro Right	18x79	15	3	-	1000	1000	
11.04.177.02 Sinistro Left	18x79	15	3	-	1000	1000	

Copritesta in PE rettangolare con testa in FE Rectangular tube cover in PE with head in FE

CRTM

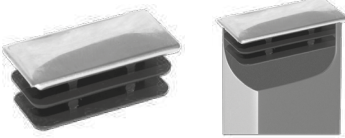
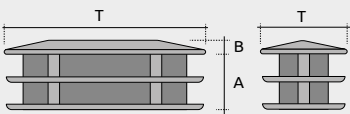
Codice Code	Testa Head	A	B	Cromato Chrome plated			
				€	Pz x conf Pcs box-bag	MOQ	
11.04.260.52	10x20	10	1,5	-	1000	2000	
11.04.261.52	15x20	10	2,0	-	1000	1000	
11.04.263.52	15x30	10	2,0	-	1000	1000	
11.04.262.52	20x40	11	2,0	-	500	1000	

Copritesta rettangolari in ABS - nero - cromato metallizzato Rectangular tube covers in ABS - black - chrome plated

CRG

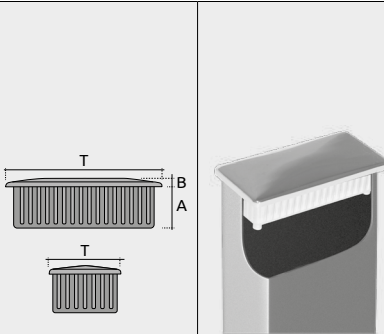
Codice Code	Testa Head	S.T.	A	B	Nero Black			Cromato Chrome plated			
					€	Pz x conf Pcs box-bag	MOQ	€	Pz x conf Pcs box-bag	MOQ	
21.04.239.00	8x15	1,0	8	2,0	-	1000	2000	-	1000	2000	
21.04.202.00	10x15	1,0	9	1,0	-	1000	2000	-	1000	2000	
21.04.207.00	10x15	1,2	9	2,5	-	1000	2000	-	1000	2000	
21.04.216.00	10x20	1,0	9	2,5	-	1000	2000	-	1000	2000	
21.04.217.00	10x20	1,2	9	2,5	-	1000	2000	-	1000	2000	
21.04.221.00	10x25	1,5	9	2,5	-	1000	2000	-	1000	2000	
21.04.224.00	10x30	1,5	9	2,5	-	500	2000	-	500	2000	
21.04.208.00	10x40	1,2	9	3,0	-	500	1000	-	500	1000	
21.04.203.00	10x40	1,5	9	3,0	-	500	1000	-	500	1000	
21.04.200.00	15x20	1,2	9	3,0	-	1000	1000	-	1000	1000	
21.04.201.00	15x20	1,5	9	3,0	-	1000	1000	-	1000	1000	
21.04.229.00	15x25	1,5	9	3,0	-	500	500	-	500	500	
21.04.209.00	15x30	1,2	9	3,0	-	500	500	-	500	500	
21.04.204.00	15x30	1,5	9	3,0	-	500	500	-	500	500	
21.04.233.00	15x35	1,5	9	3,0	-	250	500	-	250	500	
21.04.234.00	15x40	1,0	9	3,0	-	250	500	-	250	500	
21.04.210.00	15x40	1,2	9	3,0	-	250	500	-	250	500	
21.04.205.00	15x40	1,5	9	3,0	-	250	500	-	250	500	
21.04.212.00	20x30	1,2	9	3,0	-	500	500	-	500	500	
21.04.211.00	20x30	1,5	9	3,0	-	500	500	-	500	500	
21.04.214.00	20x35	1,5	9	3,0	-	250	500	-	250	500	
21.04.213.00	20x40	1,2	9	3,5	-	250	500	-	250	500	
21.04.206.00	20x40	1,5	9	3,5	-	250	500	-	250	500	
21.04.244.00	20x40	2,0	9	3,5	-	250	500	-	250	500	
21.04.241.00	20x50	1,2	10	3,0	-	200	600	-	200	600	
21.04.242.00	20x50	1,5	10	3,0	-	200	600	-	200	600	
21.04.240.00	20x60	1,5	10	3,0	-	200	600	-	200	600	

07 | Puntali ellisse ovali | Elliptical and oval inserts

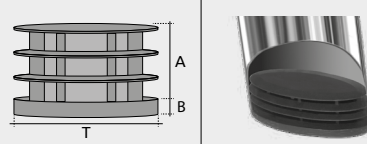
		Puntali a ellisse alettati in PE Ribbed elliptical insert in PE				Nero Black			Colorato a richiesta Coloured version on demand		
		Codice Code	Testa Head	A	B	€	Pz x conf Pcs box-bag	MOQ	€	Pz x conf Pcs box-bag	MOQ
		11.05.101.02	20x40	18	6	-	2500	5000	-	-	-
		11.05.100.02	15x30	14	4	-	6000	6000	-	-	-
		11.05.099.02	30x60	19	5	-	1500	1500	-	-	-
		11.05.098.02	34x18	16	5	-	5000	5000	-	-	-

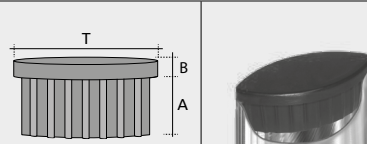
		Puntali a ellisse in PE Ribbed elliptical insert in PE				Nero Black		
		Codice Code	Testa Head	A	B	€	Pz x conf Pcs box-bag	MOQ
		11.05.190.02	30x60	15	5	-	1000	1000

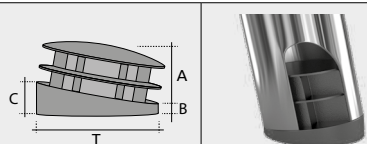
		Puntali a ellisse inclinati 10° in PE Elliptical inclined ribbed insert 10° in PE					Nero Black			Colorato a richiesta Coloured version on demand		
		Codice Code	Testa Head	A	B	C	€	Pz x conf Pcs box-bag	MOQ	€	Pz x conf Pcs box-bag	MOQ
		11.05.120.02	15x30	12	2	7	-	6000	12000	-	-	-

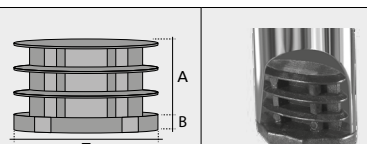
		Puntali a ellisse alettati in PE Ribbed elliptical insert in PE				Nero Black			
		Codice Code	Testa Head	A	B	€	Pz x conf Pcs box-bag	MOQ	
		21.05.102.00	15x30	16	4	-	6000	6000	
		Base con sporgenza da 1 lato per distanziare. Misure riferite all'esterno del tubo Base with one side spacer. Sizes referred to external tube							

Puntali a ellisse inclinati 15° in PE
Elliptical inclined 15°ribbed insert in PE

EIADI

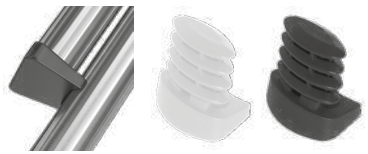
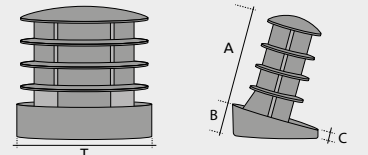
Codice Code	Testa Head	A	B	C	Nero Black			Colorato a richiesta Coloured version on demand			
					€	Pz x conf Pcs box-bag	MOQ	€	Pz x conf Pcs box-bag	MOQ	
11.05.185.02	15x30	21	9	4	-	3000	3000	-	-	-	

Puntali ovali alettati in PE
Ribbed oval insert in PE

OIA

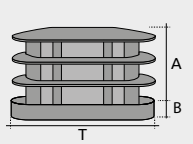
Codice Code	Testa Head	A	B	Nero Black			Colorato a richiesta Coloured version on demand			
				€	Pz x conf Pcs box-bag	MOQ	€	Pz x conf Pcs box-bag	MOQ	
11.05.109.02	12x25	12,5	5	-	2000	6000	-	-	-	
11.05.114.02	15x30	17	5	-	5000	5000	-	-	-	
11.05.112.02	18x36	18	6	-	2500	2500	-	-	-	
11.05.113.02	20x40	19	6	-	2000	2000	-	-	-	
11.05.110.02	25x50	17	5	-	2000	2000	-	-	-	
11.05.111.02	30x60	18	5	-	1250	1250	-	-	-	

Puntale alettato inclinato 15° in PE
Inclined 15° ribbed oval insert in PE

OIADI

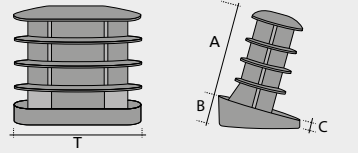
Codice Code	Testa Head	A	B	C	Nero Black			Colorato a richiesta Coloured version on demand			
					€	Pz x conf Pcs box-bag	MOQ	€	Pz x conf Pcs box-bag	MOQ	
11.05.200.02	15x30	21	9	4	-	3000	6000	-	-	-	

Puntale alettato in PE
Oval ribbed insert in PE

OIAS

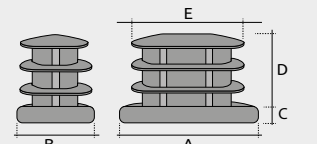
Codice Code	A	B	C	D	E	Nero Black			Colorato a richiesta Coloured version on demand			
						€	Pz x conf Pcs box-bag	MOQ	€	Pz x conf Pcs box-bag	MOQ	
11.05.116.02	34	19,3	5	16,5	27,5	-	3500	3500	-	-	-	

INDEX

PIO

Puntali ovali inclinati 12,5° in PE
Inclined ribbed oval insert 12,5° in PE

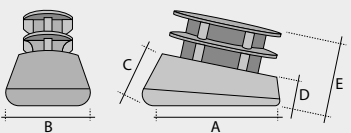
	Codice Code	A	B	C	D	E	Nero Black			Colorato a richiesta Coloured version on demand		
							€	Pz x conf Pcs box-bag	MOQ	€	Pz x conf Pcs box-bag	MOQ
	11.05.178.02	30	15	13	7	11	-	1000	1000	-	-	-
												

PIO

Puntali ovali inclinati alla base 20° e gambo 30°- PE
Ribbed oval insert inclined bottom 20° leg 30° - PE

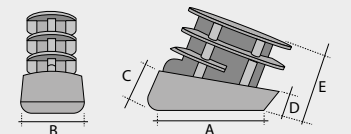
	Codice Code	A	B	C	D	E	Nero Black			Colorato a richiesta Coloured version on demand		
							€	Pz x conf Pcs box-bag	MOQ	€	Pz x conf Pcs box-bag	MOQ
	11.05.179.02	30	15	9	4	11	-	2000	2000	-	-	-
												

OAF

Puntali ovali alettati filettati in P
Ribbed oval threaded insert in PP

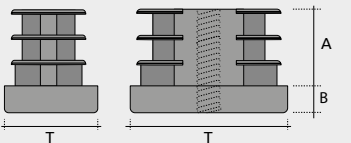
	Codice Code	Testa Head	A	B	Nero Black		
					€	Pz x conf Pcs box-bag	MOQ
	11.05.118.02	18x36	15	6,5	-	500	500
	11.05.119.02	20x40	18	6,5	-	500	500
	<p>Filetto 10 MA Misure riferite all'esterno del tubo - Da non usare per le rotelle Thread 10 MA Sizes referred to external tube - Not to use with castors</p>						

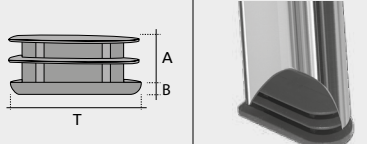

PCSO

Puntali copritesta semiovali in PE
Ribbed half-oval insert in PE

	Codice Code	Testa Head	A	B	Nero Black			Colorato a richiesta Coloured version on demand			
					€	Pz x conf Pcs box-bag	MOQ	€	Pz x conf Pcs box-bag	MOQ	
	11.06.107.02	15x30	12	3,0	-	2000	2000	-	-	-	
	11.06.113.02	20x40	13	3,5	-	1500	1500	-	-	-	
	11.06.118.02	25x40	13	3,5	-	2000	2000	-	-	-	
											

Copritesta in PE ovale con testa in FE cromato
Oval tube cover in PE with metal top

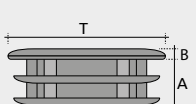
COM

Codice Code	Testa Head	A	B	Cromato Chrome plated			
				€	Pz x conf Pcs box-bag	MOQ	
11.05.168.52	10x20	10	2,0	-	1000	3000	 
11.05.165.52	15x30	10	2,5	-	1000	3000	
11.05.167.52	18x36	11	3,0	-	500	2000	
11.05.166.52	20x40	10	3,0	-	500	2000	

Copritesta a ellisse in PE
Elliptical tube cover in PE

CEI

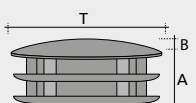
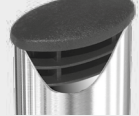
Codice Code	Testa Head	A	B	Nero Black			Colorato a richiesta Coloured version on demand			
				€	Pz x conf Pcs box-bag	MOQ	€	Pz x conf Pcs box-bag	MOQ	
11.05.105.02	15x30	10	3,0	-	2000	2000	-	-	-	 
11.05.106.02	18x36	10	3,5	-	2000	6000	-	-	-	
11.05.108.02	20x35	11	5,0	-	2500	2500	-	-	-	
11.05.107.02	20x40	11	4,0	-	2000	2000	-	-	-	

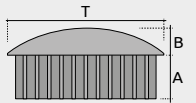
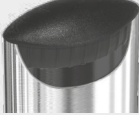

Copritesta a ellisse in PE
Elliptical tube cover in PE

CEIS

Codice Code	Testa Head	A	B	Nero Black			
				€	Pz x conf Pcs box-bag	MOQ	
11.05.195.02	30x60	15	10	-	1000	3000	 

Copritesta ovali in ABS - nero - cromato metallizzato
Oval tube cover in ABS black - chrome plated

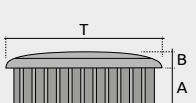
COC

Codice Code	Testa Head	S.T.	A	B	Nero Black			Cromato Metallizzato Chromed plated Brass metallized			
					€	Pz x conf Pcs box-bag	MOQ	€	Pz x conf Pcs box-bag	MOQ	
21.05.139.00	10x20	1,0	9	2,5	-	1000	3000	-	1000	3000	 
21.05.140.00	10x20	1,2	9	2,5	-	1000	3000	-	1000	3000	
21.05.144.00	10x25	1,5	9	3,0	-	1000	3000	-	1000	3000	
21.05.147.00	15x25	1,5	9	3,0	-	500	3000	-	500	3000	
21.05.134.00	15x30	1,2	10	3,0	-	500	2000	-	500	2000	
21.05.132.00	15x30	1,5	10	3,0	-	500	2000	-	500	2000	
21.05.135.00	20x30	1,2	10	3,0	-	500	1000	-	500	1000	
21.05.133.00	20x30	1,5	10	3,0	-	500	1000	-	500	1000	
21.05.136.00	20x35	1,5	10	3,0	-	250	1000	-	250	1000	
21.05.159.00	20x40	1,5	10	3,0	-	250	1000	-	250	1000	
21.05.137.00	16x32	1,2	10	3,0	-	500	500	-	500	500	
21.05.138.00	17x45	1,5	10	3,0	-	250	250	-	250	250	

INDEX

COI

Copritesta ovali alettati in PE
Oval ribbed tube cover in PE

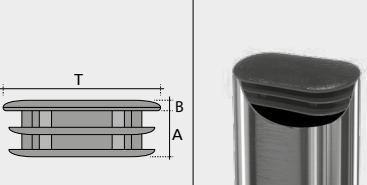
	Codice Code	Testa Head	A	B	Nero Black			Colorato a richiesta Coloured version on demand		
					€	Pz x conf Pcs box-bag	MOQ	€	Pz x conf Pcs box-bag	MOQ
	11.05.124.02	10x20	10	2	-	5000	5000	-	-	-
	11.05.125.02	15x30	10	3	-	7500	7500	-	-	-
	11.05.126.02	18x36	10	3	-	2500	2500	-	-	-
	11.05.127.02	20x40	10	4	-	3000	3000	-	-	-
	11.05.129.02	25x50	17	5	-	2000	2000	-	-	-
	11.05.128.02	30x60	22,5	3	-	1500	1500	-	-	-

CPTA

Copritesta o puntali ovali testa alta in PE
Oval tube cover large head in PE

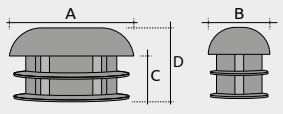
	Codice Code	A	B	C	D	Nero Black			Colorato a richiesta Coloured version on demand		
						€	Pz x conf Pcs box-bag	MOQ	€	Pz x conf Pcs box-bag	MOQ
	11.05.171.02	30	15	8	12	-	2000	2000	-	-	-

CPTA1

Copritesta ovali testa alta 1 aletta in PE
One rib oval tube cover in PE

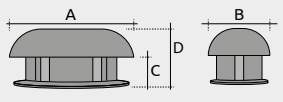
	Codice Code	A	B	C	D	Nero Black			Colorato a richiesta Coloured version on demand		
						€	Pz x conf Pcs box-bag	MOQ	€	Pz x conf Pcs box-bag	MOQ
	11.05.174.02	32	15	5	7,6	-	5000	5000	-	-	-

INDEX

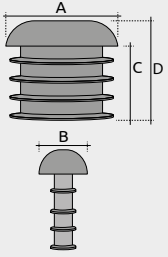
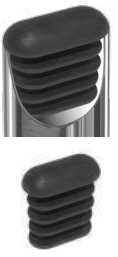
Copritesta ovale per tubo ovale Cover cap for oval tube								CONI	
Codice Code	A	B	C	D	Nero Black				
					€	Pz x conf Pcs box-bag	MOQ		
11.05.180.02	32	15	28	36	-	40	400		

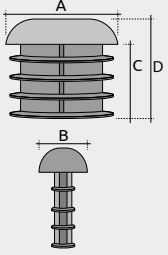
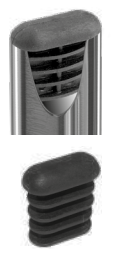
Copritesta ovale per tubo ellittico Cover cap for elliptical tube								CENI	
Codice Code	A	B	C	D	Nero Black				
					€	Pz x conf Pcs box-bag	MOQ		
11.05.181.02	32	15	28	36	-	5000	5000		

08 | Basi piane a pinza per telai filo | Clips for chair wire metal frames

BPP

Base piana a pinza in PE per tondo 8 mm
Clip for chair wire frame for tube 8 mm

	Codice Code	Base	A	B	C	Nero Black			Neutro Neutral		
						€	Pz x conf Pcs box-bag	MOQ	€	Pz x conf Pcs box-bag	MOQ
						11.06.122.02	17x24	12,5	24	17	-

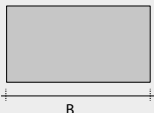
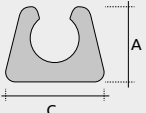
	
---	---

BPP

Base piana a pinza in PE per tondo 10 mm
Clip for chair wire frame for tube 10 mm

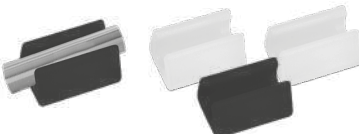
	Codice Code	Base	A	B	C	Nero Black			Bianco White			Neutro Neutral		
						€	Pz x conf Pcs box-bag	MOQ	€	Pz x conf Pcs box-bag	MOQ	€	Pz x conf Pcs box-bag	MOQ
						11.06.120.02	19x30	14,5	29,5	19	-	5000	5000	-

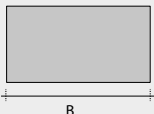
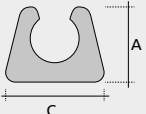
	
---	---

BPP

Base piana a pinza in PE per tondo 12 mm
Clip for chair wire frame for tube 12 mm

	Codice Code	Base	A	B	C	Neutro Neutral		
						€	Pz x conf Pcs box-bag	MOQ
						11.06.123.02	22x31	16,5

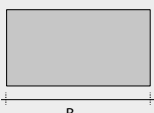
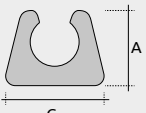
	
---	---

BPP

Base piana a pinza in PE per tondo 14 mm
Clip for chair wire frame for tube 14 mm

	Codice Code	Base	A	B	C	Nero Black			Neutro Neutral		
						€	Pz x conf Pcs box-bag	MOQ	€	Pz x conf Pcs box-bag	MOQ
						11.06.124.02	24x33	18	33	24	-

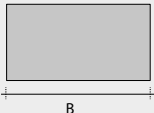
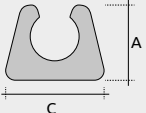
	
---	---

Base piana a pinza antirotazione in PE per tondo 11
Anti rotation clip for wire frame for tube 11 mm

BPPA

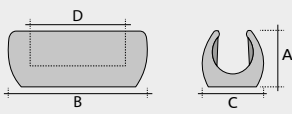
Codice Code	Base	A	B	C	D	Neutro Neutral			
						€	Pz x conf Pcs box-bag	MOQ	
11.06.130.02	17x24	14	30	17	20	-	5000	5000	

Base piana a pinza doppia per tondo 11
Clip for wire frame for tube 11 mm

BPPD

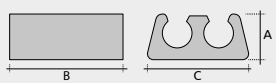
Codice Code	Base	A	B	C	D	Neutro Neutral			
						€	Pz x conf Pcs box-bag	MOQ	
11.06.135.02	35x31	16	31	35	15	-	1500	1500	

Piedino tubo slitta
Plastic clip wire frame for felt black

PSTF

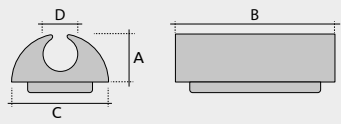
Codice Code	A	B	C	D	Nero Black			Neutro Neutral			
					€	Pz x conf Pcs box-bag	MOQ	€	Pz x conf Pcs box-bag	MOQ	
21.06.150.00	13	32	18.5	8	-	500	500	-	500	500	
21.06.151.00	14	32	19	10	-	500	500	-	500	500	
21.06.152.00	15	32	19.5	11	-	500	500	-	500	500	
21.06.153.00	16	32	20	12	-	500	500	-	500	500	
21.06.154.00	17	32	21.5	14	-	500	500	-	500	500	

Feltro per piedino tubo slitta
Felt for wire frame clip black

FPST

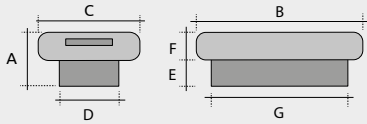
Codice Code	A	B	C	D	E	F	G	Nero Black			Neutro Neutral			
								€	Pz x conf Pcs box-bag	MOQ	€	Pz x conf Pcs box-bag	MOQ	
21.06.155.00	10	33	19	17	4	6	30	-	500	500	-	500	500	

INDEX

BTF

Piedini 4 pzi. per telaio a filo neutr
Set of 4 pcs of neutral glides for wire frames



Codice Code	A	B	C	D	E	F	G	Neutro Neutral		
								€	Pz x conf Pcs box-bag	MOQ
11.06.140.02	22	98	16.5	12	5	145°	57	-	100	100

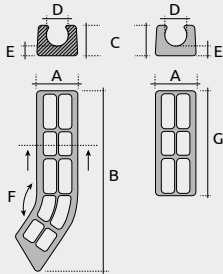

BTFA

Piedini 4 pzi. con aggancio per telaio a filo neutr
Set of 4 pcs of neutral glides with joint for wire frames

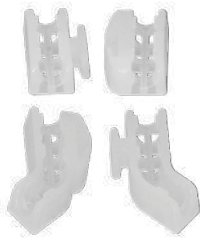

Codice Code	A	B	C	D	E	F	G	H	I	L	M	Neutro Neutral		
												€	Pz x conf Pcs box-bag	MOQ
11.06.141.02	22	57	16.5	12	5	145°	31	31.5	97	31	31.5	-	100	100

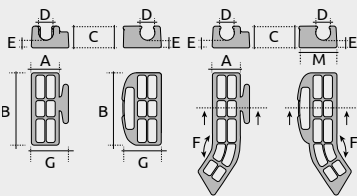

PPTF

Prolunga per piedini con agganci per telaio a filo neutri (per BT A)
Neutral joint for glides BTFA

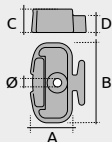

Codice Code	A	B	C	D	Ø	Neutro Neutral		
						€	Pz x conf Pcs box-bag	MOQ
11.06.142.02	29	57	16.5	12	6	-	100	100



Versione sedie senza tavoletta
Version for chairs without tablet
(02+01)

Versione sedie con tavoletta
Version for chairs with tablet
(02+05+01)

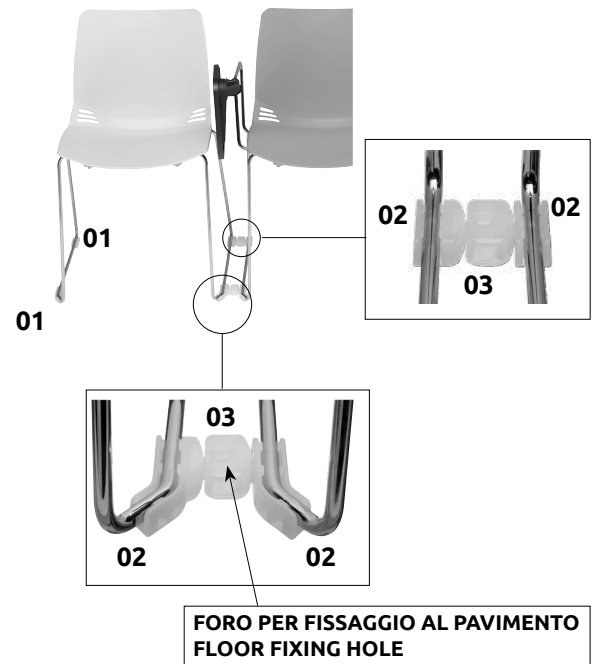
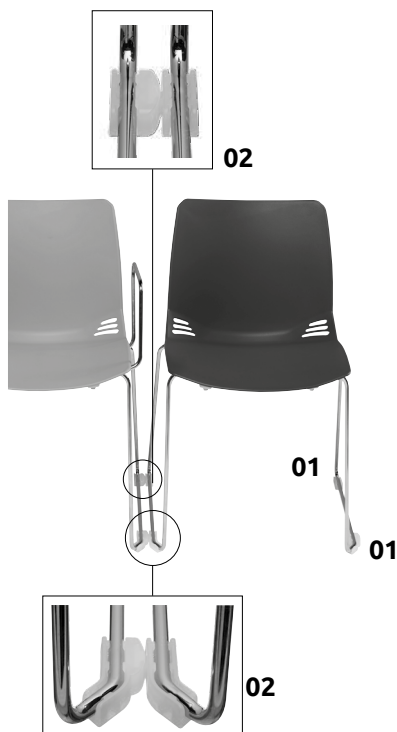



01	BTF	Piedini 4 pzi. per telaio a filo neutri Set of 4 pcs of neutral glides for wire frames	pg. 48
02	BTFA	Piedini 4 pzi. con aggancio per telaio a filo neutr Set of 4 pcs of neutral glides with joint for wire frames	pg. 48
03	PPTF	Prolunga per piedini con agganci per telaio a filo neutri per BT A (Fissaggio al pavimento) Neutral joint for glides BTFA (Floor fixing	pg. 48

09 | Puntali per esterno | Outer caps

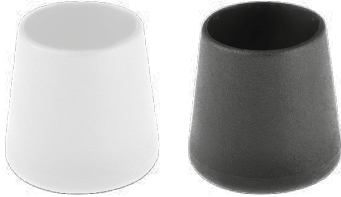
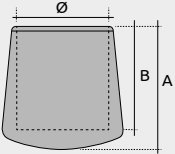

EX

Puntali export in PVC
Outer caps in PVC

	Codice Code	ØTubo ØTube	A	B	Nero Black			Colorato a richiesta Coloured version on demand			
					€	Pz x conf Pcs box-bag	MOQ	€	Pz x conf Pcs box-bag	MOQ	
							11.10.124.01	2	7,5	6	-
		11.10.125.01	3	9.5	8	-	5000	5000	-	-	-
		11.10.126.01	4	11	9	-	5000	5000	-	-	-
		11.10.127.01	5	13	10	-	5000	5000	-	-	-
		11.10.128.01	6	14	11	-	5000	5000	-	-	-
		11.10.130.01	7	14	11	-	5000	5000	-	-	-
		11.10.129.01	8	16	13	-	5000	5000	-	-	-
		11.10.132.01	10	18	14	-	5000	5000	-	-	-
		11.10.133.01	12	21	17	-	3000	3000	-	-	-
		11.10.134.01	13	21	17	-	2000	2000	-	-	-
		11.10.123.01	14	23	18	-	2000	2000	-	-	-
		11.10.135.01	16	25	20	-	2000	2000	-	-	-
		11.10.136.01	18	27	22	-	2000	2000	-	-	-
		11.10.138.01	20	30	24	-	2000	2000	-	-	-
		11.10.139.01	22	32	26	-	2000	2000	-	-	-
		11.10.147.01	25	32	29	-	1500	1500	-	-	-
		11.10.143.01	26	37	31	-	1000	1000	-	-	-
		11.10.141.01	28	38	32	-	1000	1000	-	-	-
		11.10.144.01	30	41	34	-	1000	1000	-	-	-
		11.10.142.01	32	43	39	-	800	800	-	-	-
		11.10.145.01	35	47	40	-	500	500	-	-	-
		11.10.160.01	40	33	27	-	1000	1000	-	-	-
		11.10.161.01	50	33	27	-	500	500	-	-	-

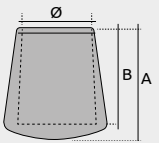

EX



Puntali export (misure speciali) in PVC
Outer caps (special sizes) in PVC

	Codice Code	ØTubo ØTube	A	B	Nero Black			Colorato a richiesta Coloured version on demand			
					€	Pz x conf Pcs box-bag	MOQ	€	Pz x conf Pcs box-bag	MOQ	
							11.10.131.01	9	17	13	-
		11.10.137.01	19	28	23	-	2000	2000	-	-	-
		11.10.140.01	24-25	36	30	-	1500	1500	-	-	-

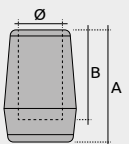

EL

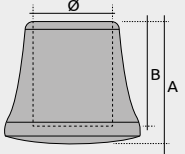

Puntali bombati lunghi in PVC
Outer caps in PVC



	Codice Code	ØTubo ØTube	A	B	Nero Black			Colorato a richiesta Coloured version on demand			
					€	Pz x conf Pcs box-bag	MOQ	€	Pz x conf Pcs box-bag	MOQ	
							11.10.231.01	10	28	22	-
		11.10.232.01	12	31	24	-	4000	4000	-	-	-
		11.10.233.01	14	34	27	-	2000	4000	-	-	-
		11.10.234.01	16	36	29	-	2000	2000	-	-	-
		11.10.235.01	18	38	31	-	2000	2000	-	-	-
		11.10.236.01	20	40	33	-	1500	3000	-	-	-



Puntali a campana in PVC Outer caps in PVC										EC	
Codice Code	ØTubo ØTube	A	B	Nero Black			Colorato a richiesta Coloured version on demand				
				€	Pz x conf Pcs box-bag	MOQ	€	Pz x conf Pcs box-bag	MOQ		
11.10.201.01	6	20	16	-	2000	4000	-	-	-		
11.10.202.01	8	23	18	-	1500	1500	-	-	-		
11.10.203.01	10	25	21	-	1500	1500	-	-	-		
11.10.204.01	12	27	23	-	1500	1500	-	-	-		
11.10.205.01	14	28	22	-	1000	1000	-	-	-		
11.10.206.01	16	29	22	-	1000	1000	-	-	-		
11.10.207.01	18	31	24	-	1000	1000	-	-	-		
11.10.208.01	20	33	26	-	1000	1000	-	-	-		
11.10.209.01	22	35	27	-	1000	1000	-	-	-		
11.10.210.01	24	35	28	-	1000	1000	-	-	-		
11.10.211.01	26	37	32	-	500	500	-	-	-		
11.10.212.01	28	41	34	-	500	500	-	-	-		
11.10.213.01	30	44	36	-	500	500	-	-	-		

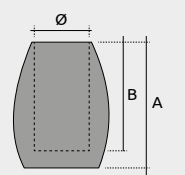

Misure riferite al Øesterno
Sizes referred to Øexternal tube del tubo

Puntali a botte in PVC Outer caps in PVC										EB	
Codice Code	ØTubo ØTube	A	B	Nero Black			Colorato a richiesta Coloured version on demand				
				€	Pz x conf Pcs box-bag	MOQ	€	Pz x conf Pcs box-bag	MOQ		
11.10.220.01	6	19	14	-	4000	4000	-	-	-		
11.10.221.01	8	21	16	-	4000	4000	-	-	-		
11.10.222.01	10	23	18	-	5000	10000	-	-	-		
11.10.223.01	12	26	20	-	2500	10000	-	-	-		
11.10.224.01	14	28	21	-	2500	10000	-	-	-		
11.10.225.01	16	30	23	-	2500	10000	-	-	-		
11.10.226.01	18	31	24	-	2500	10000	-	-	-		

Puntale esterno leggero in PE Light outer caps in PE										ETL	
Codice Code	ØTubo ØTube	A	B	Nero Black			Colorato a richiesta Coloured version on demand				
				€	Pz x conf Pcs box-bag	MOQ	€	Pz x conf Pcs box-bag	MOQ		
11.10.149.02	15	24	20	-	2000	2000	-	-	-		
11.10.150.02	16	20	14	-	2500	2500	-	-	-		
11.10.151.02	18	23	17	-	2500	5000	-	-	-		
11.10.152.02	20	25	19	-	2000	2000	-	-	-		
11.10.153.02	22	22	18	-	2500	2500	-	-	-		
11.10.154.02	24	23	17	-	2000	2000	-	-	-		
11.10.155.02	25	23	17	-	2000	2000	-	-	-		
11.10.156.02	26	25	19	-	2000	2000	-	-	-		
11.10.157.02	28	26	20	-	2000	4000	-	-	-		
11.10.158.02	30	27	21	-	1500	1500	-	-	-		

INDEX

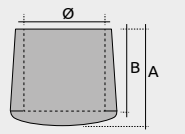
PPL

Puntali per piedi letto in PE
Insert for bed feet in PE

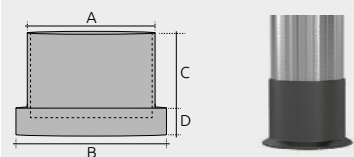

Codice Code	A	B	C	D	Nero Black		
					€	Pz x conf Pcs box-bag	MOQ
11.23.141.02	Ø50	Ø64	32	9,5	-	350	350

ERI

Puntali inclinati 20° in PVC
Round 20° inclined insert in PVC

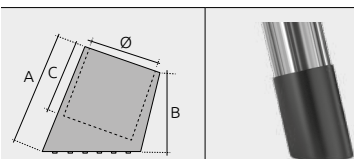

Codice Code	ØTubo ØTube	A	B	C	Nero Black			Colorato a richiesta Coloured version on demand		
					€	Pz x conf Pcs box-bag	MOQ	€	Pz x conf Pcs box-bag	MOQ
11.10.185.01	25	38	27	20	-	1500	1500	-	-	-

ERL

Puntale esterno rettangolare 15X30
Outer square caps 15x30

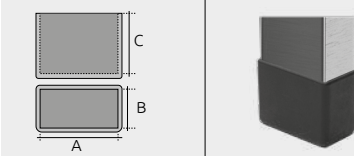

Codice Code	A	B	C	Nero Black		
				€	Pz x conf Pcs box-bag	MOQ
11.10.250.02	30	15	23	-	3000	3000

EF

Puntale esterno trasparente con feltro
Outer caps with felt pads

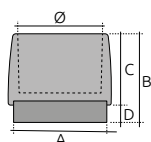

Codice Code	Ø	A	B	C	D	Trasparente Transparent		
						€	Pz x conf Pcs box-bag	MOQ
21.10.260.00	12	14	21	16	5	-	500	500
21.10.261.00	14	16	21	16	5	-	500	500
21.10.262.00	16	18	21	16	5	-	500	500
21.10.263.00	18	20	21	16	5	-	500	500
21.10.264.00	20	22	21	16	5	-	500	500
21.10.265.00	22	24	21	16	5	-	500	500
21.10.266.00	25	27	21	16	5	-	500	500

Puntale esterno ovale con base inclinata in PVC
Oval outer cap with inclined base in PVC

POB2

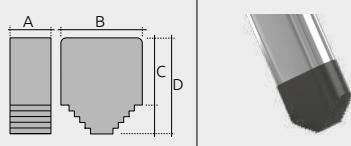
Codice Code	A	B	C	D	Nero Black			Colorato a richiesta Coloured version on demand			
					€	Pz x conf Pcs box-bag	MOQ	€	Pz x conf Pcs box-bag	MOQ	
11.11.170.01	15	30	26	40	-	1000	1000	-	-	-	

Puntale esterno ovale in PVC
Oval outer cap in PVC

PEO

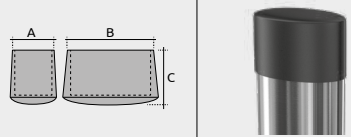
Codice Code	A	B	C	Nero Black			Colorato a richiesta Coloured version on demand			
				€	Pz x conf Pcs box-bag	MOQ	€	Pz x conf Pcs box-bag	MOQ	
11.11.174.01	15	30	23	-	3000	3000	-	-	-	
11.11.175.01	18	36	27	-	1500	1500	-	-	-	
11.11.176.01	20	40	28	-	1500	1500	-	-	-	

Puntale esterno ovale in PVC
Oval outer cap insert in PVC

PEE

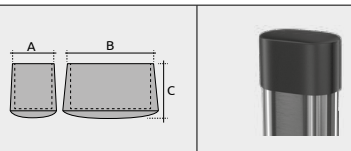
Codice Code	A	B	C	Nero Black			Colorato a richiesta Coloured version on demand			
				€	Pz x conf Pcs box-bag	MOQ	€	Pz x conf Pcs box-bag	MOQ	
11.11.120.01	30	15	23	-	3500	7000	-	-	-	

Piedi scala artiglio in PVC
Ladder insert in PVC

PSAR

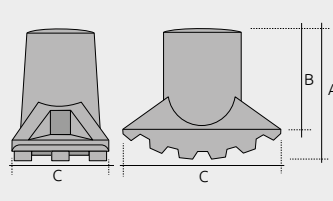
Codice Code	Ø	A	B	C	Nero Black			
					€	Pz x conf Pcs box-bag	MOQ	
11.11.141.01	30	69	53	78 x 42	-	200	200	
11.11.142.01	32	72	59	82 x 45	-	200	200	
11.11.143.01	35	71	56	86 x 46	-	150	150	
11.11.144.01	38	83	67	92 x 52	-	150	150	
11.11.145.01	40	78	62	91 x 52	-	100	100	

INDEX

PSAO

Piedi scala artiglio in PVC
Ladder glides in PVC

	Codice Code	D	A	B	C	Nero Black		
						€	Pz x conf Pcs box-bag	MOQ
	11.11.161.01	20x40	70	57	90x37	-	200	200
	11.11.162.01	25x50	89	77	110x46	-	100	1000

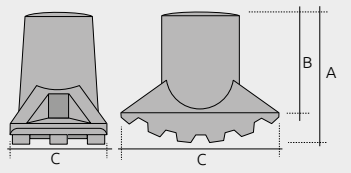
	
---	--

PSP

Piedi scala a pera in PVC
Ladder glide in PVC

	Codice Code	ØTubo ØTube	A	B	C	Nero Black		
						€	Pz x conf Pcs box-bag	MOQ
	11.11.151.01	20	35	29	31	-	1000	1000
	11.11.152.01	28	48	40	44	-	500	500
	11.11.153.01	30	47	38	42	-	400	400
	11.11.154.01	32	49	40	45	-	400	400
	11.11.155.01	35	53	42	48	-	300	300
	11.11.156.01	38	57	45	53	-	300	300
	11.11.157.01	40	59	47	56	-	200	200
	11.11.158.01	45	64	52	61	-	200	200

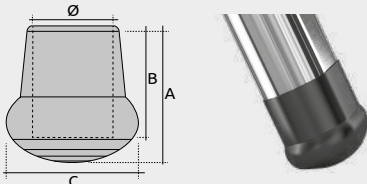
	
---	--

PSPO

Puntali scala a pera ovali in PVC
Ladder oval glide in PVC

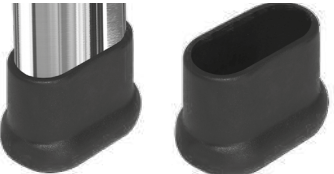
	Codice Code	Misura Size	A	B	C	Nero Black		
						€	Pz x conf Pcs box-bag	MOQ
	11.11.165.01	40x20	40	34	52x32	-	600	600
	11.11.166.01	50x25	50	43	65x40	-	300	300

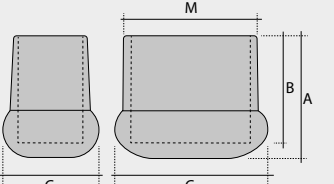
	
---	--

Puntali per angolari in PE
Angular insert in PE

ASC

Codice Code	A	B	C	Spessore Thickness	Nero Black		
					€	Pz x conf Pcs box-bag	MOQ
11.12.104.02	11,5	9,5	27	1.5 - 2	-	3500	7000
11.12.100.02	12,5	10	30	2	-	3000	3000
11.12.101.02	12,5	10	35	2	-	3000	3000
11.12.102.02	13	10	40	2	-	2250	2250
11.12.103.02	12,5	10	32	3	-	3000	3000

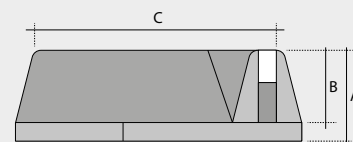
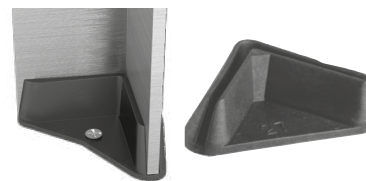

Puntali doppio angolare in PE
Double angular insert in PE

ADS

Codice Code	A	B	C	D	Spessore Thickness	Nero Black		
						€	Pz x conf Pcs box-bag	MOQ
11.12.105.02	12,5	10	70	35	2	-	1000	5000

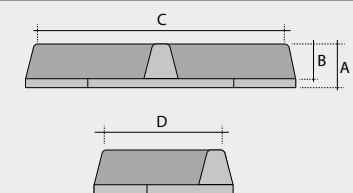
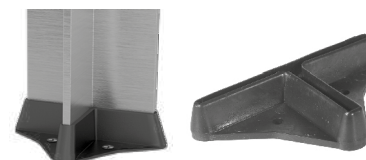

Puntali per angolari a L in PE
Angular bases L type in PE

ASL

Codice Code		A	B	C	D	Spessore Thickness	Nero Black		
							€	Pz x conf Pcs box-bag	MOQ
11.12.110.02	Destra right	12.5	9.5	55	35	2	-	1000	5000
11.12.112.02	Destra right	13.0	10.0	40	20	2	-	5000	5000
11.12.111.02	Sinistra Left	12.5	9.5	55	35	2	-	1000	5000
11.12.113.02	Sinistra Left	13.0	10.0	40	20	2	-	5000	5000

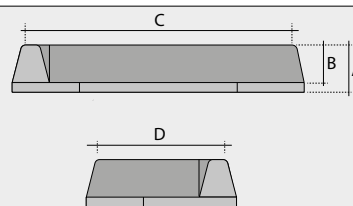

INDEX

AUS

Puntali angolari a U in PVC
Angular insert U type in PVC

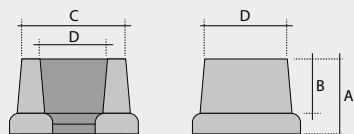

Codice Code	A	B	C	D	Spessore Thickness	Nero Black		
						€	Pz x conf Pcs box-bag	MOQ
11.12.115.01	25	18	35	30	2	-	500	1000

EA

Puntali angolari in PE
Angular insert in PE

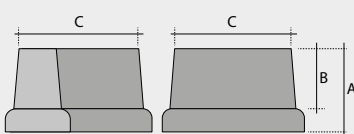

Codice Code	A	B	C	Nero Black		
				€	Pz x conf Pcs box-bag	MOQ
11.12.121.02	20	15	20	-	2000	2000
11.12.122.02	24	19	25	-	2000	2000
11.12.123.02	24	19	30	-	1000	1000
11.12.124.02	24	19	35	-	1000	1000

Adatti per essere infilati negli appoggi ad angolo
Suitable for angle supports

EAL

Puntali angolari base diritta in PE
Angular insert in PE

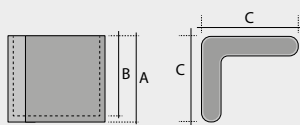

Codice Code	A	B	C	Nero Black		
				€	Pz x conf Pcs box-bag	MOQ
11.12.129.02	25	20	25	-	2000	2000

PEP

Puntale esterno per piatto in PVC
Angular insert in PVC

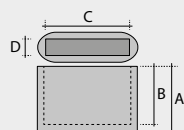
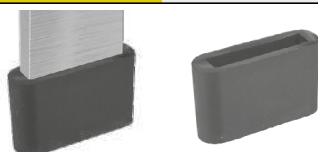

Codice Code	A	B	C	D	Nero Black		
					€	Pz x conf Pcs box-bag	MOQ
11.12.135.01	19	15	25	8	-	2500	5000
11.12.138.01	19	15	25	5	-	2500	5000
11.12.136.01	19	15	25	6	-	2500	5000
11.12.137.01	19	15	30	6	-	2500	5000

Innesti per tubo quadro 20x20 in ABS
Square tube connectors 20x20 in ABS

ITQ

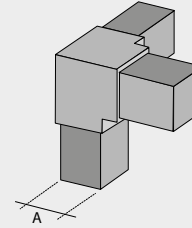
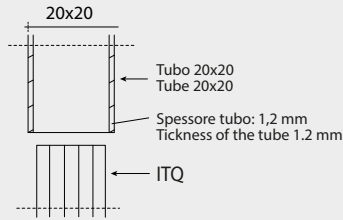

Tubo spessore mm 1,2 | Tube thickness mm 1,2

(R) Su richiesta | On demand

Codice Code	Mod	Per tubo misure esterna: 20x20	A	Nero Black			Cromato Chrome plated		
				€	Pz x conf Pcs box-bag	MOQ	€	Pz x conf Pcs box-bag	MOQ
21.12.201.00	3 vie ways	20x20	17,6	-	50	50	-	50	(R)
21.12.202.00	4 vie ways	20x20	17,6	-	50	50	-	50	(R)
21.12.203.00	5 vie ways	20x20	17,6	-	50	50	-	50	(R)
21.12.204.00	6 vie ways	20x20	17,6	-	50	50	-	50	(R)
21.12.205.00	mod a "L" "L" type	20x20	17,6	-	50	100	-	50	(R)
21.12.206.00	mod a "T" "T" type	20x20	17,6	-	50	50	-	50	(R)
21.12.207.00	Croce Cross	20x20	17,6	-	50	50	/	/	/

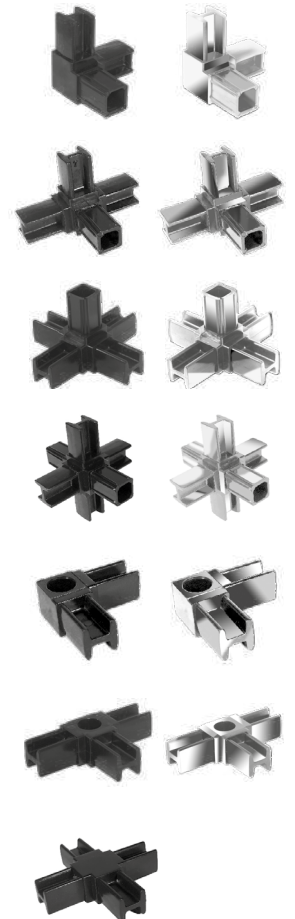

ITQ

Innesti per tubo quadro 25x25 in ABS
Square tube connectors 25x25 in ABS

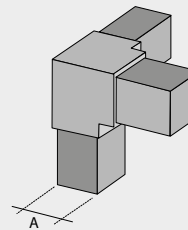
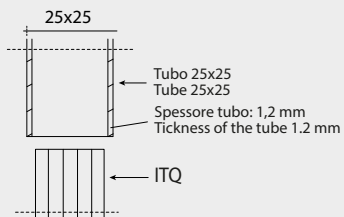

Tubo spessore mm 1,2 | Tube thickness mm 1,2

(R) Su richiesta | On demand

	Codice Code	Mod	Per tubo misure esterna: 25x25	A	Nero Black			Cromato Chrome plated		
					€	Pz x conf Pcs box-bag	MOQ	€	Pz x conf Pcs box-bag	MOQ
	21.12.211.00	3 vie ways	25x25	22,6	-	25	50	-	25	(R)
	21.12.212.00	4 vie ways	25x25	22,6	-	25	50	-	25	(R)
	21.12.213.00	5 vie ways	25x25	22,6	-	25	50	-	25	(R)
	21.12.215.00	mod a "L" "L" type	25x25	22,6	-	25	100	-	25	(R)

Reggi lamiera @ Gambo per foro Ø5 in PA neutro
Metal support leg hole Ø5 in neutral PA

RL

Codice Code	A	B	C	D	E	Neutro Neutral		
						€	Pz x conf Pcs box-bag	MOQ
11.17.126.05	11,5	12	9	5	4	-	5000	5000

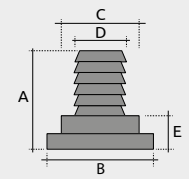

Copriforo per serramenti in PVC
Tube cover for windows in PVC

CFS

Codice Code	A	B	C	D	Nero Black			Grigio Grey		
					€	Pz x conf Pcs box-bag	MOQ	€	Pz x conf Pcs box-bag	MOQ
11.91.101.01	16	11,5	2	2,5	-	5000	5000	-	5000	10000

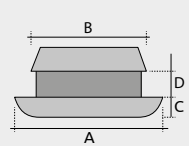

Protezione aletta thonet in PE
Protection thonet fin in P

PAT

Codice Code	A	B	C	Nero Black		
				€	Pz x conf Pcs box-bag	MOQ
11.17.119.02	27,5	20	8	-	5000	5000

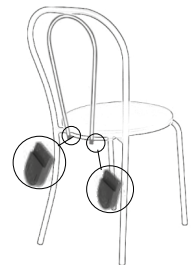
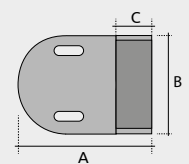

Manopole per carriole in PE
Handle for wheelbarrow in PE

MAC

Codice Code	A	B	Nero Black			Colorato Coloured		
			€	Pz x conf Pcs box-bag	MOQ	€	Pz x conf Pcs box-bag	MOQ
12.01.233.02	Ø28	92	-	600	600	-	600	10000
12.01.238.02	Ø30	92	-	600	600	-	600	10000
12.01.239.02	Ø32	92	-	600	600	-	600	10000

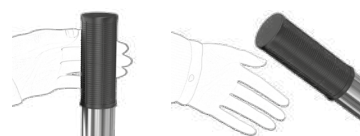
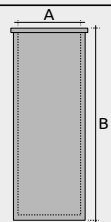

INDEX

PRM

Paraspigoli per mobili in PE
Corner cover for furniture in PE



Codice Code	A	B	C	Nero Black		
				€	Pz x conf Pcs box-bag	MOQ
11.17.105.02	60	60	26	-	1250	1250

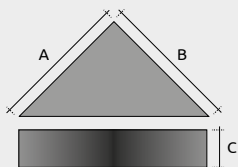

PRM

Paraspigoli per mobili in PE
Corner cover for furniture in PE

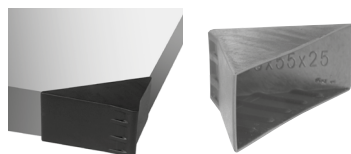

Codice Code	A	B	C	Nero Black		
				€	Pz x conf Pcs box-bag	MOQ
11.17.106.02	55	55	30	-	750	750
11.17.108.02	55	55	25	-	750	750
11.17.109.02	55	55	20	-	750	750

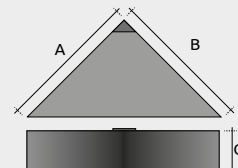

PRMS

Paraspigolo sagomato per mobili in PE
Corner cover for furniture in PE

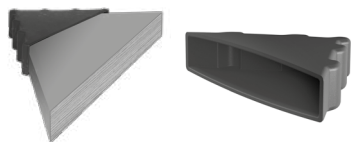

NEW

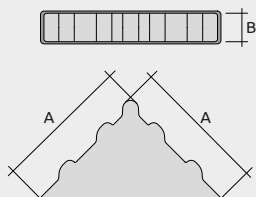

Codice Code	A	B	Nero Black		
			€	Pz x conf Pcs box-bag	MOQ
11.17.139.02	55	10	-	2000	2000
11.17.140.02	114	19	-	500	500
11.17.141.02	114	25	-	400	400
11.17.142.02	114	30	-	300	300

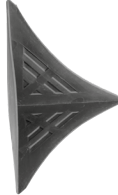
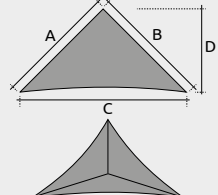

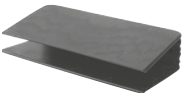
						Paraspigolo triangolare Triangularcorner cover			PRMT
Codice Code	A	B	C	D	Nero Black				
					€	Pz x conf Pcs box-bag	MOQ		
11.17.150.02	70,7	70,7	100	50	-	1000	1000	 	

						Paraspigolo a sezione per mobili in PE Sectional corner cover for furniture in PE			PMS
Codice Code	A	B	Nero Black						
			€	Pz x conf Pcs box-bag	MOQ				
11.17.145.02	19	100	-	1000	3000	 			
11.17.146.02	25	100	-	800	4000				
11.17.147.02	30	100	-	700	700				
									

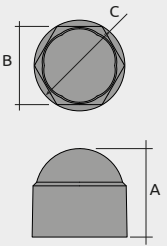
 							Coprifido bullone nero Edge protector			CD
	Codice Code	A	B	C	Dado	Nero Black				
						€	Pz x conf Pcs box-bag	MOQ		
11.27.140.02	14,6	13	16	M8	-	5000	5000			
11.27.141.02	18,8	17	20	M10	-	5000	5000			
11.271.42.02	19,3	19	23	M12	-	5000	5000			

SP

Sottopiede a pinza in PE
Saddle feet in PE

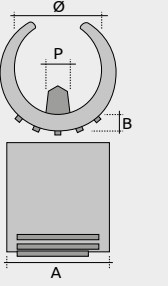
	Codice Code	Misura Size	ØPiolo ØPeg	A	B	Nero Black			Colorato a richiesta Coloured version on demand		
						€	Pz x conf Pcs box-bag	MOQ	€	Pz x conf Pcs box-bag	MOQ
	11.20.181.02	14 - 16	5,5	18	3,5	-	4000	4000	-	-	-
	11.20.182.02	16 - 18	5,5	19	3,5	-	4000	4000	-	-	-
	11.20.183.02	18 - 20	5,5	20	3,5	-	4000	4000	-	-	-
	11.30.011.02	18 - 20	4,0	18	3,5	-	4000	10000	-	-	-
	11.20.185.02	20 - 22	5,5	22	4,0	-	3000	3000	-	-	-
	11.20.184.02	24 - 26	5,5	25	5,0	-	3000	3000	-	-	-
	11.20.243.02	24 - 26	7,5	25	5,0	-	3000	3000	-	-	-
	11.20.186.02	28 - 30	7,5	30	5,5	-	1750	1750	-	-	-
	11.20.050.02	22 - 24	4,0	22	4,0	-	4000	4000	-	-	-

SPL

Sottopiede a pinza lungo in PE
Saddle feet long type in PE

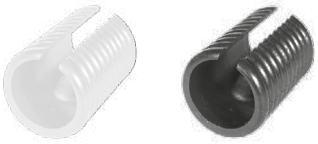
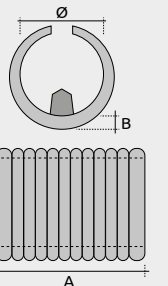
	Codice Code	Misura Size	ØPiolo ØPeg	A	B	Nero Black			Colorato a richiesta Coloured version on demand		
						€	Pz x conf Pcs box-bag	MOQ	€	Pz x conf Pcs box-bag	MOQ
	11.20.176.02	18 - 20	6	46	4,5	-	1500	1500	-	-	-
	11.20.178.02	24 - 26	8	46	5,0	-	1000	1000	-	-	-
	11.20.179.02	28 - 30	8	46	5,5	-	1000	1000	-	-	-

SPQ

Sottopiede pinza quadra 25X25
Square foot piller 25x25

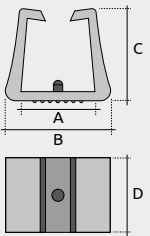
	Codice Code	A	B	C	D	Nero Black		
						€	Pz x conf Pcs box-bag	MOQ
	11.30.009.02	25	34	31	25	-	2000	10000

Pinza per tubo Ø25 P5.5 nera con base tonda
Saddle foot with round base for tube Ø25

SPBT

Codice Code	A	B	C	D	Nero Black		
					€	Pz x conf Pcs box-bag	MOQ
11.70.211.05	25	5	32	30	-	4000	10000

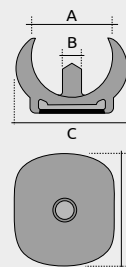

Distanziatore a pinza in PE
Saddle feet in PE

DP

Codice Code	Misure Size	A	B	Nero Black			Bianco White		
				€	Pz x conf Pcs box-bag	MOQ	€	Pz x conf Pcs box-bag	MOQ
11.20.206.02	18-20	18	3,0	-	4000	4000	-	-	-
11.20.207.02	24-26	18	3,5	-	2000	2000	-	-	-

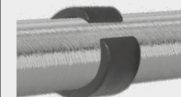
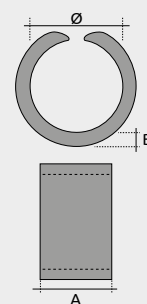

Anello sottopiede in PVC
Feet ring in PVC

AS

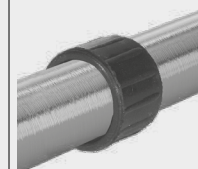
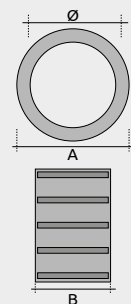

Codice Code	ØInterno ØInner	A	B	Nero Black			Colorato a richiesta Coloured version on demand		
				€	Pz x conf Pcs box-bag	MOQ	€	Pz x conf Pcs box-bag	MOQ
11.20.195.01	14	19	13	-	5000	5000	-	-	-
11.20.196.01	16	22	15	-	5000	5000	-	-	-
11.20.197.01	18	24	16	-	5000	5000	-	-	-
11.20.198.01	20	26	17	-	5000	5000	-	-	-



INDEX

P2P

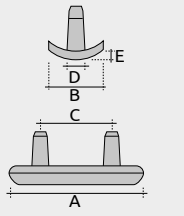
Pinza a 2 pioli in PE
Plier two posts in PE

	Codice Code	A	B	C	D	E	Nero Black			Neutro Neutral		
							€	Pz x conf Pcs box-bag	MOQ	€	Pz x conf Pcs box-bag	MOQ
	11.20.200.02	33	13,5	18	4,5	2,5	-	10000	10000	-	10000	10000
												

P2PA

Pinza a 2 pioli in PE
Plier two posts in PE

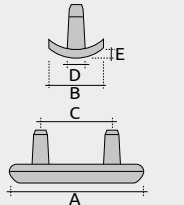
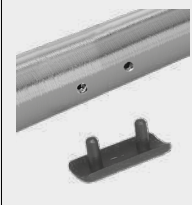
	Codice Code	A	B	C	D	E	Nero Black			
							€	Pz x conf Pcs box-bag	MOQ	
	11.30.010.02	33	13,5	18	4,5	5	-	10000	10000	
										

P2PF

Pattino con feltro a 2 perni
Plier two posts with felt

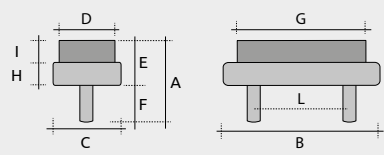
	Codice Code	A	B	C	D	E	F	G	H	I	L	Nero Black		
												€	Pz x conf Pcs box-bag	MOQ
	21.70.360.00	17	32	12	10	7	10	30	3	4	18	-	500	500
														

PAR

Piedino a 90° antiribaltamento in PP
Feet 90° anti-tipping glide in PP

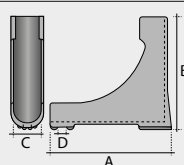
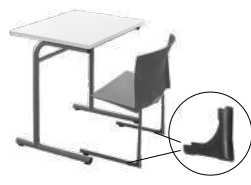
	Codice Code	A	B	C	D	Nero Black		
						€	Pz x conf Pcs box-bag	MOQ
	11.20.191.02	106	100	Ø25	Ø5,5	-	300	300
								

Piedino antiribaltamento in PP
Anti-tipping glide in PP

PARP

Codice Code	A	B	C	D	R	Nero Black		
						€	Pz x conf Pcs box-bag	MOQ
11.20.192.02	43	19	Ø25	Ø5	60	-	2000	2000

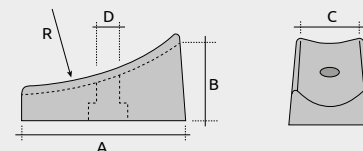
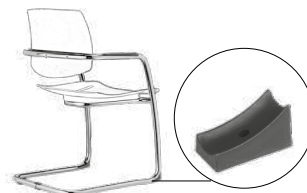

Piedino antiribaltamento per telaio slitta D25
Anti-tipping glide for cantilever D25

PART

Codice Code	A	B	C	D	E	F	G	H	I	L	M	Nero Black		
												€	Pz x conf Pcs box-bag	MOQ
11.70.119.02	105	28	55	12	18	Ø10	Ø5.5	71	2.5	4	13	-	500	500

Gli articoli PART e PATS non sono vendibili singolarmente
PART and PATS feet are not for separate sale

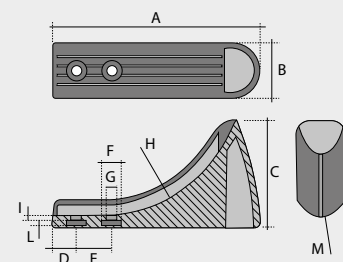
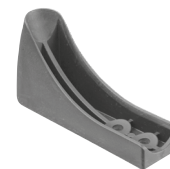

Piedino anteriore per telaio slitta D25
Front glide for cantilever D25

PATS

Codice Code	A	B	C	D	E	F	G	H	I	L	Nero Black		
											€	Pz x conf Pcs box-bag	MOQ
11.70.118.02	34	70	34	35	35	Ø10	Ø5.5	2.5	4	2	-	500	500

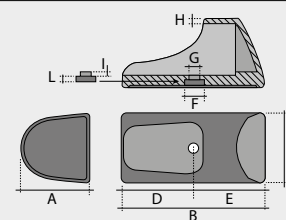

Gli articoli PART e PATS non sono vendibili singolarmente
PART and PATS feet are not for separate sale



INDEX

CSPR

Copritesta semiovale porta ruote
Semioval tube cover for castors

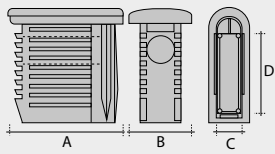
 		Codice Code 11.20.158.02	A 40	B 20	C Ø10	D P26	Nero Black		
							€ -	Pz x conf Pcs box-bag 1500	MOQ 1500

CSB

Coprisaldatura base 5 razze
Welding cover for 5 leg bases

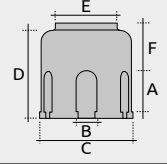
 	Codice Code 11.20.270.02 11.20.271.02	A Ø40 Ø40	B 20 20	C Ø80 Ø80	D 87 87	E Ø40 Ø50	F 6 6	Nero Black		
								€ - -	Pz x conf Pcs box-bag 180 180	MOQ 180 180



PSL

Protezione scocche legno in PVC
Protection for wooden chairs in PVC

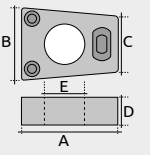
 	Codice Code 11.22.164.01	A 38	B 29	C 22	D 11	E 16	Neutro Neutral		
							€ -	Pz x conf Pcs box-bag 2500	MOQ 2500

PTF

Protezione per telaio ovale
Protection for oval tube frame

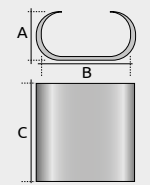
 	Codice Code 11.22.162.02	A 15	B 30	C 30	Nero Black		
					€ -	Pz x conf Pcs box-bag 2500	MOQ 2500

PTT

Protezione per telaio tondo
Protection for round tube frame

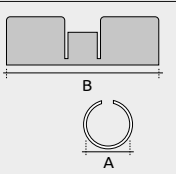
 	Codice Code 11.22.155.02	A 22	B 69	Nero Black		
				€ -	Pz x conf Pcs box-bag 2500	MOQ 2500

Agganci ad omega in PP
Hooks in PP

AGO

Codice Code	Per tubo For tube	A	B	C	D	E	Nero Black		
							€	Pz x conf Pcs box-bag	MOQ
11.22.165.02	Ø25	64	27	44	25	Ø5,8	-	500	500
11.22.166.02	Ø20	52	26	35	20	Ø6	-	1000	1000
11.22.167.02	Ø16	52	26	35	16	Ø6	-	1000	2000

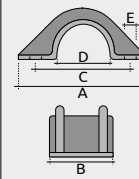

Bracciolo sagomato in PS tubo Ø25
Curved armrest in PS - tube Ø25

BS

Codice Code	A	B	C	D	E	Nero Black		
						€	Pz x conf Pcs box-bag	MOQ
11.20.170.03	305	17	35	45	172	-	120	500

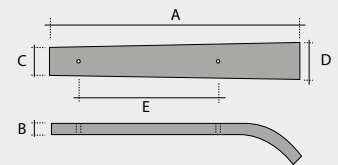

Bracciolo sagomato in PS con buccole filetta e M6 in ottone per tubo Ø25
Curved armrest in PS with threaded nuts M6 for tube Ø25

BSB

Codice Code	A	B	C	D	E	Nero Black		
						€	Pz x conf Pcs box-bag	MOQ
11.20.171.30	305	17	35	45	172	-	120	500

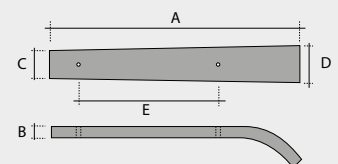
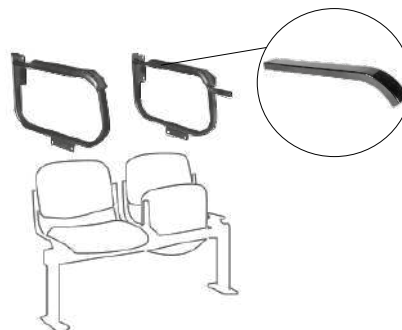

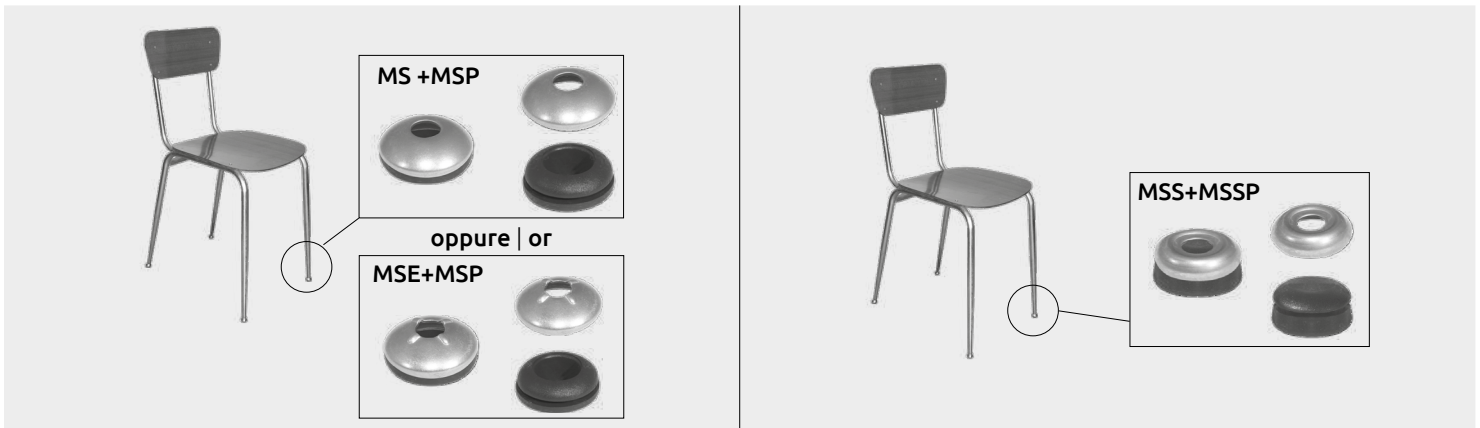

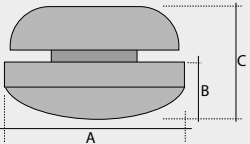

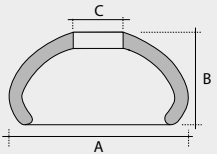
MSP 	Base plastica in PE Round plastic snap insert in PE			Nero Black			
	Codice Code	A	B	C	€	Pz x conf Pcs box-bag	MOQ
	11.21.110.02	19	6,0	13	-	5000	5000
	11.21.111.02	26	6,5	13	-	3000	3000

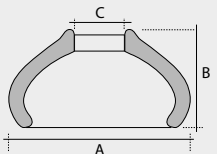

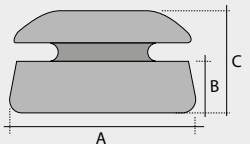
MS 	Borchia liscia per saldatura autogena in FE Smooth iron stud for welding			Metallo Metal			
	Codice Code	A	B	C	€	Pz x conf Pcs box-bag	MOQ
	11.21.101.67	20,0	9,0	6,7	-	5000	5000
	11.21.102.67	28,5	9,5	9,0	-	3000	3000

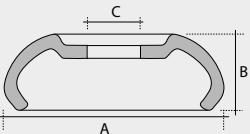

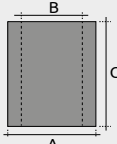
MSE 	Borchia con sporgenza per saldatura elettrica in FE Smooth iron stud for welding			Metallo Metal			
	Codice Code	A	B	C	€	Pz x conf Pcs box-bag	MOQ
	11.21.103.67	20,0	9,5	6,7	-	2500	5000
	11.21.104.67	28,5	10,0	8,7	-	1500	1500

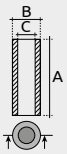

MSSP 	Base plastica piana in PE Plastic insert in PE			Nero Black			
	Codice Code	A	B	C	€	Pz x conf Pcs box-bag	MOQ
	11.21.112.02	18,5	5	10	-	2500	5000

MSS 	Borchia testa sagomata in FE Flat stud in FE			Metallo Metal			
	Codice Code	A	B	C	€	Pz x conf Pcs box-bag	MOQ
	11.21.105.67	20,5	7,5	7	-	2500	5000

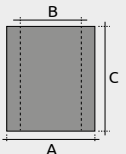
Tubetto distanziatore in PE Spacers in PE										TD
Codice Code	A	B	C	Nero Black			Colorato a richiesta Coloured version on demand			
				€	Pz x conf Pcs box-bag	MOQ	€	Pz x conf Pcs box-bag	MOQ	
11.22.100.02	8	4	5	-	5000	10000	-	-	-	
11.22.101.02	8	5	3,7	-	5000	5000	-	-	-	
11.22.102.02	10	4	20	-	5000	5000	-	-	-	
11.22.103.02	10	6	4	-	5000	5000	-	-	-	
11.22.104.02	10	6	6	-	5000	5000	-	-	-	
11.22.105.02	10	6	9	-	5000	5000	-	-	-	
11.22.106.02	10	6	10	-	5000	5000	-	-	-	
11.22.107.02	10	6	12	-	5000	5000	-	-	-	
11.22.108.02	10	6	14	-	5000	5000	-	-	-	
11.22.109.02	10	6	15	-	5000	5000	-	-	-	
11.22.110.02	10	6	17	-	5000	5000	-	-	-	
11.22.111.02	10	6	19	-	5000	5000	-	-	-	
11.22.112.02	11	4	10	-	5000	5000	-	-	-	
11.22.113.02	11,5	7,5	5	-	10000	10000	-	-	-	
11.22.121.02	12	8	5	-	5000	10000	-	-	-	
11.22.114.02	12	8,5	6	-	5000	5000	-	-	-	
11.22.115.02	13	6,3	3,5	-	5000	5000	-	-	-	
11.22.116.02	14	5	3	-	5000	5000	-	-	-	
11.22.119.02	14	5	9	-	5000	5000	-	-	-	
11.22.117.02	14	6,5	7	-	5000	5000	-	-	-	
11.22.118.02	17	6	10	-	5000	5000	-	-	-	
11.22.123.02	24	10	15	-	2500	2500	-	-	-	

Tubetto distanziatore PA-FV Spacers PA-FV							TDE
Codice Code	A	B	C	Nero Black			
				€	Pz x conf Pcs box-bag	MOQ	
11.22.136.05	38	Ø14	Ø8,4	-	-	-	

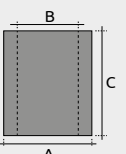
Tubetto distanziatore in PP Spacers in PP							DB
Codice Code	A	B	C	Nero Black			
				€	Pz x conf Pcs box-bag	MOQ	
11.20.349.02	17,5	8	12	-	3000	3000	

Tubetto distanziatore in PE Spacers in PE							DR
Codice Code	A	B	C	Nero Black			
				€	Pz x conf Pcs box-bag	MOQ	
11.20.492.02	22,5	7,3	18,8	-	1000	5000	

INDEX

TC

Tubetti paracolpi ciechi in PVC
Buffers in P C

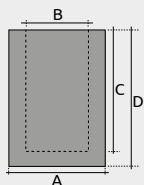
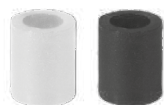

Codice Code	A	B	C	D	Nero Black			Colorato a richiesta Coloured version on demand		
					€	Pz x conf Pcs box-bag	MOQ	€	Pz x conf Pcs box-bag	MOQ
11.22.190.01	17	12	21	24	-	5000	5000	-	-	-
11.22.191.01	14	6	16,5	18	-	5000	5000	-	-	-

TDI

Tubetti distanziatori con incavo in PE
Spacers in PE with cavity

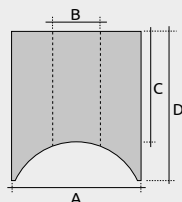

Codice Code	A	B	C	D	Nero Black			Colorato a richiesta Coloured version on demand		
					€	Pz x conf Pcs box-bag	MOQ	€	Pz x conf Pcs box-bag	MOQ
11.22.125.02	13	5,5	5	9,5	-	5000	10000	-	-	-
11.22.126.02	13	5,5	7	11,5	-	5000	10000	-	-	-
11.22.127.02	13	5,5	14	18	-	5000	5000	-	-	-
11.22.128.02	17	6	5	9	-	5000	5000	-	-	-
11.22.129.02	17	6	7	11,5	-	5000	5000	-	-	-
11.22.130.02	17	6	10	14,5	-	5000	5000	-	-	-
11.22.131.02	17	6	14	18,5	-	5000	5000	-	-	-
11.22.132.02	17	6	16	21	-	5000	5000	-	-	-

DZC

Distanziatore conico nero
Spacers with hole

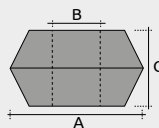

Codice Code	A	B	C	Nero Black		
				€	Pz x conf Pcs box-bag	MOQ
11.22.140.02	14	5	9	-	10000	10000

DZB

Distanziatore bombato zigrinato in PE
Round spacers in PE

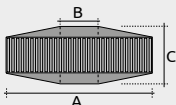

Codice Code	A	B	C	Bianco White		
				€	Pz x conf Pcs box-bag	MOQ
11.22.141.02	20	5	8	-	10000	10000

DZL

Distanziatore liscio in PE
Round spacers in PE

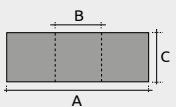

Codice Code	A	B	C	Nero Black			Colorato a richiesta Coloured version on demand		
				€	Pz x conf Pcs box-bag	MOQ	€	Pz x conf Pcs box-bag	MOQ
11.22.142.02	20	6,5	7	-	5000	5000	-	-	-

Paracolpi troncoconici in PVC
Cone buffer in P C

PT

Codice Code	A	B	C	D	Nero Black			Colorato a richiesta Coloured version on demand			
					€	Pz x conf Pcs box-bag	MOQ	€	Pz x conf Pcs box-bag	MOQ	
					11.22.171.01	29	12	13,5	5	-	
11.22.172.01	25	10	9	3	-	5000	5000	-	-	-	
11.22.230.01	22	13,5	10	5	-	3000	3000	-	-	-	
11.22.173.01	21	11	9	4	-	5000	5000	-	-	-	
11.22.174.01	19	10	9	4	-	5000	5000	-	-	-	
11.22.175.01	19	13	8	4	-	5000	5000	-	-	-	
19.02.260.01	19	13	8	5	-	2500	25000	-	-	-	
11.22.176.01	18,5	18	8	4	-	5000	5000	-	-	-	
11.22.177.01	18	8	7	3	-	5000	5000	-	-	-	
11.22.178.01	13	6	6	3	-	5000	5000	-	-	-	

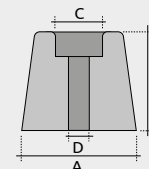

Rondella sottovite svasata in PA
Countersunk washer in PA

RSS

Codice Code	A	B	C	D	Nero Black			Colorato a richiesta Coloured version on demand			
					€	Pz x conf Pcs box-bag	MOQ	€	Pz x conf Pcs box-bag	MOQ	
					11.22.147.05	Ø15	Ø5,4	Ø10	3	-	

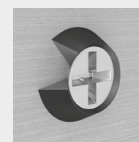
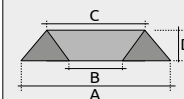

Paracolpi con incavo in PVC
Buffers with hole in P C

PIT

Codice Code	A	B	C	D	E	Nero Black			Colorato a richiesta Coloured version on demand			
						€	Pz x conf Pcs box-bag	MOQ	€	Pz x conf Pcs box-bag	MOQ	
						11.22.186.01	20	9	14	9	5	
11.22.187.01	23	12	18	10	5	-	3000	3000	-	-	-	

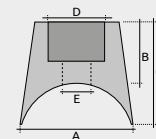

Paracolpi con incavo cilindrici in PVC
Cylindrical buffers with hole in P C

PIC

Codice Code	A	B	C	D	E	Nero Black			Colorato a richiesta Coloured version on demand			
						€	Pz x conf Pcs box-bag	MOQ	€	Pz x conf Pcs box-bag	MOQ	
						11.22.221.01	25	20	28	15	6	

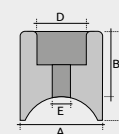

INDEX

FBP

Ferma battute porte in PVC
Door buffer in P C

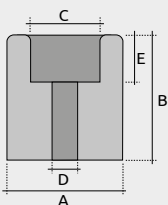

Codice Code	A	B	C	D	E	Nero Black			Colorato a richiesta Coloured version on demand		
						€	Pz x conf Pcs box-bag	MOQ	€	Pz x conf Pcs box-bag	MOQ
11.22.223.01	Ø20	23	Ø10	Ø4	7	-	2000	2000	-	-	-
11.22.224.01	Ø25	24	Ø11	Ø5	7	-	2000	2000	-	-	-
11.22.225.01	Ø30	25	Ø16	Ø6	8	-	1250	1250	-	-	-

TFS

Tappetino forato svuotato in PE
PE spacer

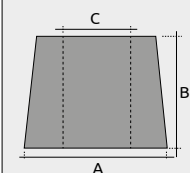

Codice Code	A	B	C	Nero Black		
				€	Pz x conf Pcs box-bag	MOQ
11.22.180.02	25	19,5	10	-	3000	3000

RP

Rondelle paracolpi in PVC
Washers in PVC

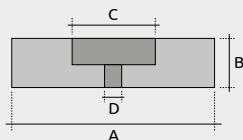

Codice Code	A	B	C	D	Nero Black			Colorato a richiesta Coloured version on demand		
					€	Pz x conf Pcs box-bag	MOQ	€	Pz x conf Pcs box-bag	MOQ
11.22.211.01	25	6	10	2	-	5000	5000	-	-	-
11.22.212.01	22	6	10	3	-	5000	5000	-	-	-
11.22.213.01	18	6	9,5	3	-	5000	5000	-	-	-
11.22.214.01	15	5	8,5	5	-	5000	5000	-	-	-
11.22.215.01	10	5	5	3	-	5000	5000	-	-	-

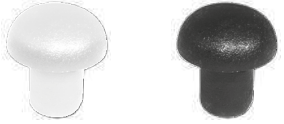
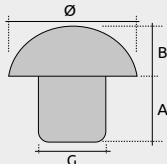
											Testa rotonda Round head buffe	PF1
Codice Code	ØTesta Øhead	Øgambo Østem	A	B	Nero Black			Colorato a richiesta Coloured version on demand				
					€	Pz x conf Pcs box-bag	MOQ	€	Pz x conf Pcs box-bag	MOQ		
Duri Hard												
11.22.235.02	9	5	6	3	-	5000	5000	-	-	-		
11.22.236.02	14	9	6	4,5	-	5000	5000	-	-	-		
11.22.237.02	14	6	15	6,5	-	5000	5000	-	-	-		
11.22.238.02	20	10	10	8	-	5000	5000	-	-	-		
Elastici Soft												
11.22.235.01	9	5	6	3	-	5000	5000	-	-	-		
11.22.236.01	14	9	6	4,5	-	5000	5000	-	-	-		
11.22.237.01	14	6	15	6,5	-	5000	5000	-	-	-		
11.22.238.01	20	10	10	8	-	5000	5000	-	-	-		

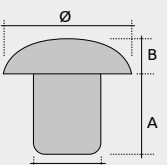
											Testa bombata Round head buffe	PF2
Codice Code	ØTesta Øhead	Øgambo Østem	A	B	Nero Black			Colorato a richiesta Coloured version on demand				
					€	Pz x conf Pcs box-bag	MOQ	€	Pz x conf Pcs box-bag	MOQ		
Duri Hard												
11.22.245.02	9,5	5	6	3	-	5000	5000	-	-	-		
11.22.246.02	12	6	7,5	3	-	5000	5000	-	-	-		
11.22.247.02	14	6	15	4	-	5000	5000	-	-	-		
11.22.248.02	18	8	15	5	-	5000	5000	-	-	-		
11.22.249.02	20	8	15	5	-	5000	5000	-	-	-		
11.22.250.02	24	11	13	5	-	5000	5000	-	-	-		
Elastici Soft												
11.22.245.01	9,5	5	6	3	-	5000	5000	-	-	-		
11.22.246.01	12	6	7,5	3	-	5000	5000	-	-	-		
11.22.247.01	14	6	15	4	-	5000	5000	-	-	-		
11.22.248.01	18	8	15	5	-	5000	5000	-	-	-		
11.22.249.01	20	8	15	5	-	5000	5000	-	-	-		
11.22.250.01	24	11	13	5	-	5000	5000	-	-	-		

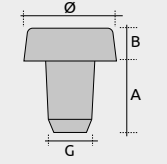
											Testa piatta Flat head buffe	PF3
Codice Code	ØTesta Øhead	Øgambo Østem	A	B	Nero Black			Colorato a richiesta Coloured version on demand				
					€	Pz x conf Pcs box-bag	MOQ	€	Pz x conf Pcs box-bag	MOQ		
Duri Hard												
11.22.255.02	12	6	9	2,5	-	5000	5000	-	-	-		
11.22.256.02	12	6	9	3,8	-	5000	5000	-	-	-		
11.22.257.02	7	3,5	5	1,5	-	5000	5000	-	-	-		
Elastici Soft												
11.22.255.01	12	6	9	2,5	-	5000	5000	-	-	-		
11.22.256.01	12	6	9	3,8	-	5000	5000	-	-	-		
11.22.257.01	7	3,5	5	1,5	-	5000	5000	-	-	-		

INDEX

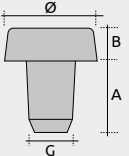
PF3		Testa piatta trasparente in PVC Transparent flat buffer in C										
		Codice Code	ØTesta Øhead	Øgambo Østem	A	B	Trasparenti Transparent					
							€	Pz x conf Pcs box-bag	MOQ			
		11.22.256.01U	12	6	9	3,8	-	5000	5000			

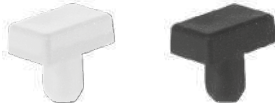
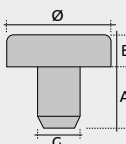

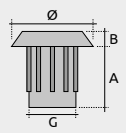
PF4		Testa rettangolare Rectangular head buffe										
		Codice Code	ØTesta Øhead	Øgambo Østem	A	B	Nero Black			Colorato a richiesta Coloured version on demand		
							€	Pz x conf Pcs box-bag	MOQ	€	Pz x conf Pcs box-bag	MOQ
		Duri Hard										
		11.22.270.02	15x10	6	9	4.5	-	5000	5000	-	-	-
		11.22.271.02	15x10	6	9	10	-	5000	5000	-	-	-
		Elastici Soft										
		11.22.270.01	15x10	6	9	4.5	-	5000	5000	-	-	-
		11.22.271.01	15x10	6	9	10	-	5000	5000	-	-	-

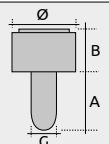

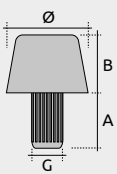
PF5		Testa bassa Low head buffe										
		Codice Code	ØTesta Øhead	Øgambo Østem	A	B	Nero Black			Colorato a richiesta Coloured version on demand		
							€	Pz x conf Pcs box-bag	MOQ	€	Pz x conf Pcs box-bag	MOQ
		Duri Hard										
		11.22.263.02	12.5	8	9	2	-	5000	5000	-	-	-
		Elastici Soft										
		11.22.263.01	12.5	8	9	2	-	5000	5000	-	-	-

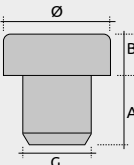

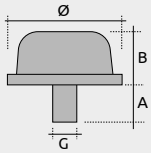
PF13		Paracolpi rotondi in PVC Round buffers in P C										
		Codice Code	ØTesta Øhead	Øgambo Østem	A	B	Nero Black			Colorato a richiesta Coloured version on demand		
							€	Pz x conf Pcs box-bag	MOQ	€	Pz x conf Pcs box-bag	MOQ
		Elastici Soft										
		13.01.260.01	11	4,2	10	7	-	5000	5000	-	-	-

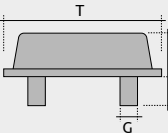

PF14		Paracolpi a tronco di cono in PE Conical buffers in P										
		Codice Code	ØTesta Øhead	Øgambo Østem	A	B	Nero Black			Colorato a richiesta Coloured version on demand		
							€	Pz x conf Pcs box-bag	MOQ	€	Pz x conf Pcs box-bag	MOQ
		Duri Hard										
		11.22.314.02	12-16	6	12	11	-	5000	5000	-	-	-

											Testa piatta Flat buffe	PF3B	
Codice Code	ØTesta Øhead	PVC	PE	G	A	B	Nero Black			Trasparenti TrSPARENT			
							€	Pz x conf Pcs box-bag	MOQ	€	Pz x conf Pcs box-bag	MOQ	
11.22.260.01	15	V	-	11	11	5,2	/	/	/	-	5000	20000	
11.22.260.02	15	-	V	11	11	5,2	-	5000	5000	/	/	/	

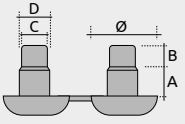
											Paracolpi con gambo in PE bianchi White insert with bolt in PE	PF15
Codice Code	ØTesta Øhead	G	A	B	Bianco White							
					€	Pz x conf Pcs box-bag	MOQ					
11.22.318.02	17	5	8,5	6,5	-	5000	5000					
11.22.319.02	23,5	5	8,5	10	-	5000	5000					

											Paracolpi con 2 gambi in PE bianchi White insert with 2 bolts in PE	PF16
Codice Code	ØTesta Øhead	G	A	B	Bianco White							
					€	Pz x conf Pcs box-bag	MOQ					
11.22.339.02	43x15,5	5	8	12	-	4000	4000					

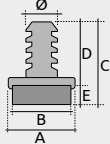
											Paracolpi 4 pezzi per stendibiancheria in PE Inserts in 4 pcs	P4P
Codice Code	ØTesta Øhead	A	B	C	D	Nero Black						
						€	Pz x conf Pcs box-bag	MOQ				
11.22.160.02	13	7	4	5	6	-	5500	5500				

											Paracolpi a perno con feltro Push in feet with felt pad	PFF
Codice Code	Ø	A	B	C	D	E	Nero Black					
							€	Pz x conf Pcs box-bag	MOQ			
21.22.340.00	6	14	12	21,5	16,5	5	-	500	500			
21.22.341.00	8	18	15	21,5	16,5	5	-	500	500			

18 | Paracolpi a scatto | Snap buffers

PF7

Paracolpi testa bombata in PVC
Buffers with round head in P C

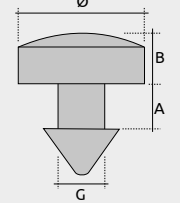

Codice Code	ØTesta Øhead	Øgambo Østem	A	B	Nero Black			Colorato a richiesta Coloured version on demand		
					€	Pz x conf Pcs box-bag	MOQ	€	Pz x conf Pcs box-bag	MOQ
Elastici Elastic										
11.22.290.01	12	5	4,5	4	-	5000	5000	-	-	-

PF9

Paracolpi testa rotonda in PVC
Round head buffer in P C

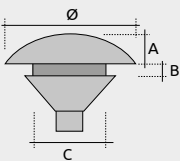

Codice Code	ØTesta Øhead	A	B	C	Nero Black			Colorato a richiesta Coloured version on demand		
					€	Pz x conf Pcs box-bag	MOQ	€	Pz x conf Pcs box-bag	MOQ
Elastici Elastic										
11.22.295.01	8	1,5	1	4	-	5000	5000	-	-	-

PF10

Paracolpi testa bombata in PVC
Round head buffer in P C

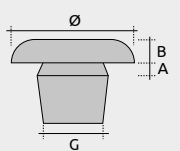

Codice Code	ØTesta Øhead	Øgambo Østem	A	B	Nero Black			Colorato a richiesta Coloured version on demand		
					€	Pz x conf Pcs box-bag	MOQ	€	Pz x conf Pcs box-bag	MOQ
Elastici Elastic										
11.22.299.01	12	6	1	2	-	5000	5000	-	-	-
11.22.300.01	12	6	1	4,5	-	5000	5000	-	-	-

PF12

Paracolpi con piolini in PVC
Buffer with posts in P C

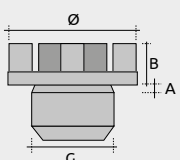

Codice Code	ØTesta Øhead	Øgambo Østem	A	B	Nero Black			Colorato a richiesta Coloured version on demand		
					€	Pz x conf Pcs box-bag	MOQ	€	Pz x conf Pcs box-bag	MOQ
Elastici Elastic										
11.22.310.01	12	7	1	4	-	5000	5000	-	-	-
11.22.311.01	12	7	1	6	-	5000	5000	-	-	-

Paracolpi con chiodo testa rotonda in PE bianchi
Round head buffer with nail in P

PF6

Codice Code	ØTesta Øhead	A	B	Bianco White		
				€	Pz x conf Pcs box-bag	MOQ
Duri Hard						
21.22.305.00	8,5	10	3,5	-	5000	5000
11.22.278.25	16	12	5	-	5000	5000

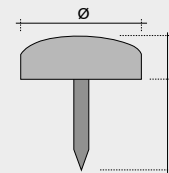

Paracolpi con 2 chiodi in PE bianchi
Buffer with double nail in P

PF8

Codice Code	ØTesta Øhead	A	B	Bianco White		
				€	Pz x conf Pcs box-bag	MOQ
Duri Hard						
11.22.285.25	46X16	10	14	-	2000	8000

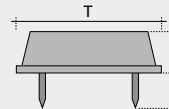

Paracolpi con chiodo in PVC
Buffer with nail in P C

PC

Codice Code	A	B	C	Nero Black			Colorato a richiesta Coloured version on demand		
				€	Pz x conf Pcs box-bag	MOQ	€	Pz x conf Pcs box-bag	MOQ
11.22.195.57	25	9	19	-	1000	1000	-	-	-
11.22.196.57	20	6	15	-	1000	2000	-	-	-
11.22.197.57	15	12	15	-	1000	1000	-	-	-
11.22.198.57	15	7	15	-	1000	1000	-	-	-

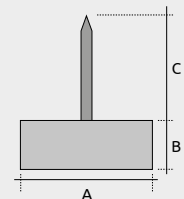
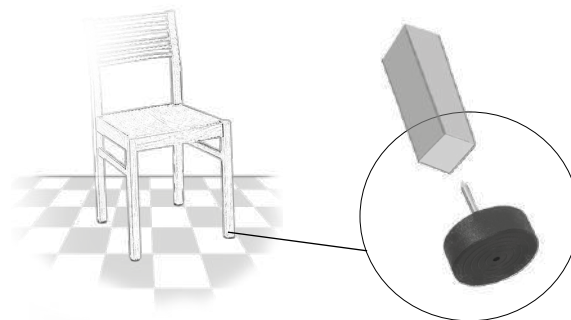

PBF

Paracolpi con chiodo e pattino in feltro
Buffer with nail and base in fel

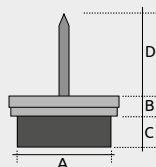

Codice Code	A	B	C	D	Marrone Brown		
					€	Pz x conf Pcs box-bag	MOQ
21.22.206.00	Ø20	5	5	15	-	1000	1000
21.22.207.00	Ø25	5	5	15	-	500	1000
21.22.200.00	Ø30	5	5	15	-	1000	1000

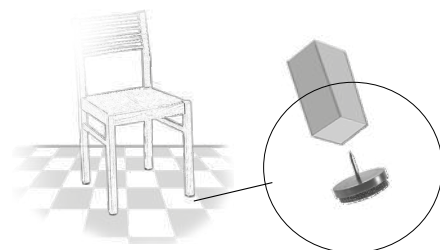

PP

Paracolpi con chiodo e pattino in FE cromato
Buffer with nail and chrome op

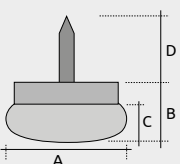

Codice Code	A	B	C	D	Cromato Chrome plated		
					€	Pz x conf Pcs box-bag	MOQ
11.22.201.58	15	10	6	13	-	1000	2000
11.22.203.58	20	11	6	13	-	500	3000
11.22.205.58	25	12	7	13	-	500	3000
11.22.209.58	40	13	7	17	-	250	500

Adatto a moquette o tappeto
Suitable for moquette or carpet

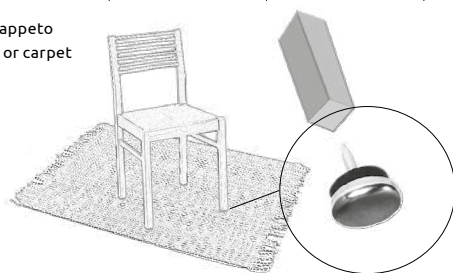

PPP

Paracolpi con chiodo e pattino in plastica
Buffer with nail and plastic op

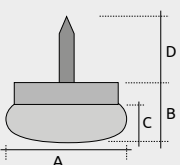

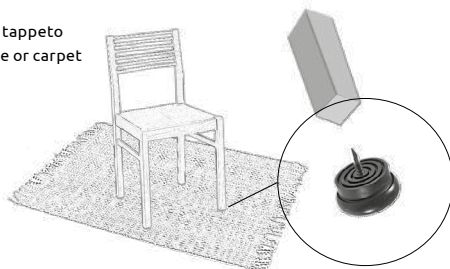

Codice Code	A	B	C	D	Nero Black		
					€	Pz x conf Pcs box-bag	MOQ
11.22.205.13	25	12	6	13	-	500	500

Adatto a moquette o tappeto
Suitable for moquette or carpet



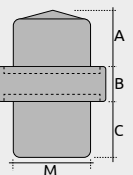

Innesto quadro per letti a castello in PA neutro
Square connector for castle-bed in neutral PA

IQC

Codice Code	Misura Size	S.T.	A	B	C	Neutro Neutral			
						€	Pz x conf Pcs box-bag	MOQ	
11.23.126.05	30x30	1,5	17	11,5	19	-	500	1000	
11.23.127.05	25x25	1,5	17,5	10	19	-	1500	1500	

Innesto rotondo per letti a castello in PA neutro
Round connector for castle-bed in neutral PA

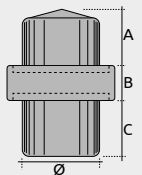
IRC

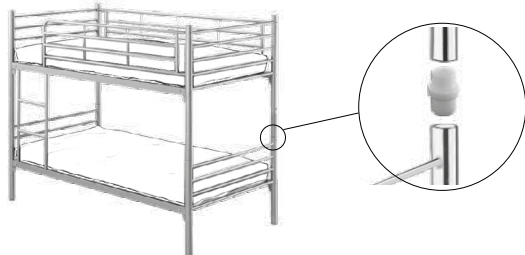
Codice Code	Misura Size	S.T.	A	B	C	Neutro Neutral			
						€	Pz x conf Pcs box-bag	MOQ	
11.23.128.05	28	1,5	17,0	11	18,5	-	1000	3000	
									

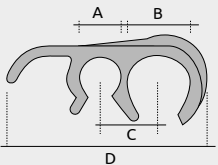

Pinze ferma brande in PP neutro
Clips in neutral PP

PFB

Codice Code	A	B	C	D	Neutro Neutral			
					€	Pz x conf Pcs box-bag	MOQ	
11.23.117.02	16	25	23	77	-	1000	3000	

Pinze ferma brande in PP neutro
Clips in neutral PP

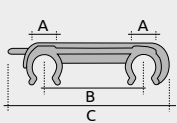
PFB

Codice Code	A	B	C	Neutro Neutral				
				€	Pz x conf Pcs box-bag	MOQ		
11.23.118.02	15-16	36	85	-	500	500		

INDEX

PFB

Pinze ferma brande in PP neutro
Clips in neutral PP



Codice Code	A	B	C	Neutro Neutral		
				€	Pz x conf Pcs box-bag	MOQ
11.23.119.02	24-25	89	137	-	450	450

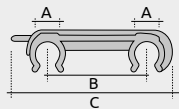

PFB

Pinze ferma brande in PP
Clips in PP



Codice Code	A	B	C	Nero Black		
				€	Pz x conf Pcs box-bag	MOQ
11.23.150.02	14	100	146	-	650	1300

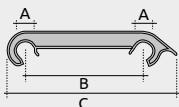

PFB

Pinze ferma brande in PP
Clips in PP



Codice Code	A	B	C	Nero Black		
				€	Pz x conf Pcs box-bag	MOQ
11.23.151.02	14	138	187	-	350	2100

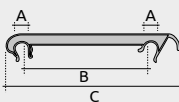

Coppia pinze regolabili per tubo ovale 15x30 in PP
Clips for oval tube 15x30 in PP

CPR

Codice Code	A	B	C	Nero Black		
				€	Pz x conf Pcs box-bag	MOQ
11.23.122.02	15X30	214	134	-	200	200

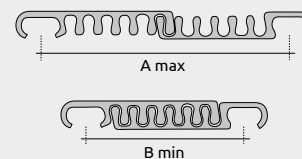

Coppia pinze regolabili per tubo Ø18 - 20 in PP
Clips for tube Ø18 - 20 in PP

CPRX

Codice Code	Tubo Tube	A max	B min	Nero Black		
				€	Pz x conf Pcs box-bag	MOQ
11.23.123.02	Ø18-20	204	124	-	200	200

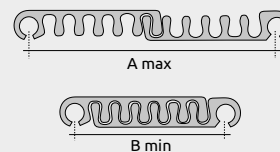

Pinza unione sedie per tubo ovale in PP nero
Clips for oval tube in black PP

PUS

Codice Code	A	B	C	Nero Black		
				€	Pz x conf Pcs box-bag	MOQ
11.23.120.02	15	30	60,5	-	500	500

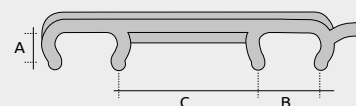

INDEX

GPL

Giunti porta aste letti in PP nero
Connectors in black PP



Codice Code	A	B	C	D	Nero Black		
					€	Pz x conf Pcs box-bag	MOQ
11.23.135.02	25	26,5	76	8	-	500	500

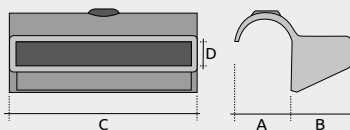

GPLD

Giunti porta aste letti doppi in PP nero
Double connectors in black PP



Codice Code	A	B	C	D	Nero Black		
					€	Pz x conf Pcs box-bag	MOQ
11.23.136.02	25	69	76	8	-	250	250

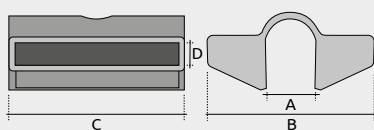

RAR

Reggi aste rettangolare in PE nero
Rectangular rod-trayer in black PE



Codice Code	A	B	C	D	Nero Black		
					€	Pz x conf Pcs box-bag	MOQ
11.23.137.02	30	73x12,5	70	8	-	1000	3000
11.23.139.02	15	72x14	69,5	10	-	1500	1500

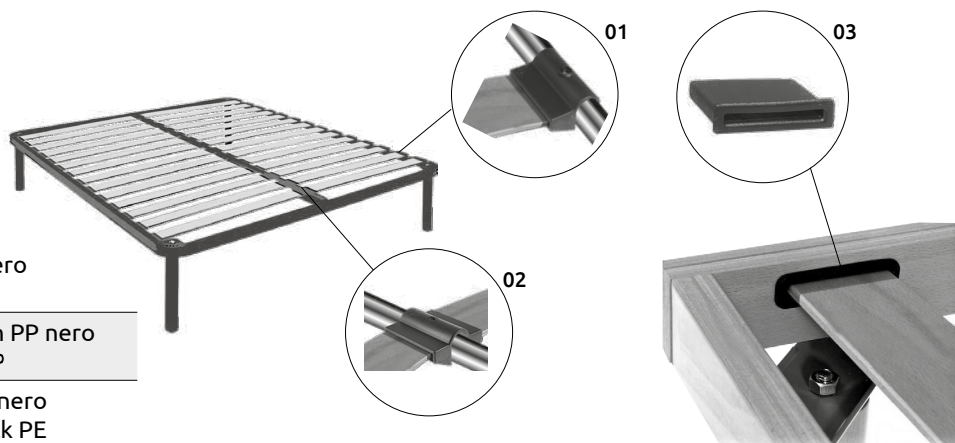
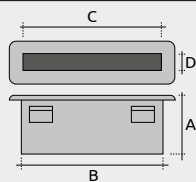

01	GPL	Giunti porta aste letti in PP nero Connectors in black PP
02	GPLD	Giunti porta aste letti doppi in PP nero Double connectors in black PP
03	RAR	reggi aste rettangolare in PE nero Rectangular rod-trayer in black PE

Copritesta per molle reti in PE neutro
Cover caps for net spring in neutral PE

CMR

Codice Code	A	B	C	D	Neutro Neutral		
					€	Pz x conf Pcs box-bag	MOQ
11.23.115.02	17,5	16	8	13,5	-	5000	5000

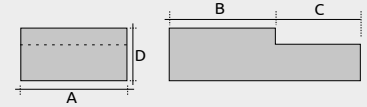

Reggi aste con pioli in PE
Rod-trayer with peg in PE

RAP

Codice Code	A	B	C	D	E	Nero Black			Colorato a richiesta Coloured version on demand		
						€	Pz x conf Pcs box-bag	MOQ	€	Pz x conf Pcs box-bag	MOQ
11.23.138.02	54	9	8,5	39	30	-	1500	1500	-	-	-
11.23.133.02	70	9	8,5	40	36	-	1000	10000	/	/	/

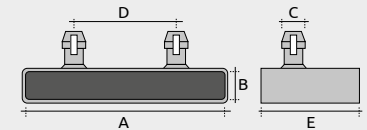

Reggi aste arcuato con pioli in PE
Arched rod-trayer with peg in PE

RAPAL

Codice Code	A	B	C	D	E	Nero Black		
						€	Pz x conf Pcs box-bag	MOQ
11.23.155.02	54	9	8,5	39	27	-	1500	1500

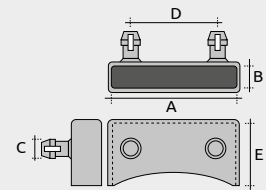

Puntali per brande inclinato 20° in PE
Inclined 20° inserts in PE

EBI

Codice Code	A	B	C	D	Nero Black		
					€	Pz x conf Pcs box-bag	MOQ
11.23.140.02	25	40	24	36	-	1700	5100

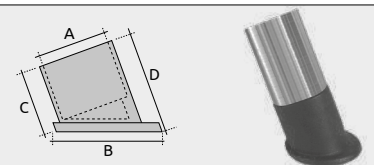

INDEX

PPL

Puntali per piedi letto in PE
Inserts in PE



Codice Code	A	B	C	D	Nero Black		
					€	Pz x conf Pcs box-bag	MOQ
11.23.141.02	Ø50	Ø64	32	9,5	-	350	350

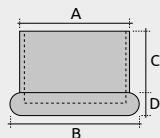

PTL

Puntale testa larga Ø40 per tubo spess.1
Big head insert Ø40 for tube thickness 1 mm

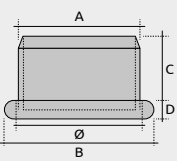

Codice Code	Ø	A	B	C	D	Nero Black		
						€	Pz x conf Pcs box-bag	MOQ
11.01.183.02	40	38	49	20	6	-	1250	1250

STL

Supporto per testate letti in PA
Support for headboard in PA



Codice Code	A	B	C	D	E	Bianco White		
						€	Pz x conf Pcs box-bag	MOQ
11.23.125.05	14	35	15	31	8	-	1000	1000

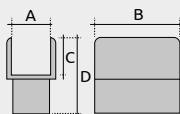

SARE

Supporto ad arco per rete elettrosaldata
Arched support for elecrowelded net

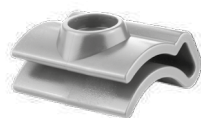

Codice Code	A	B	Grigio RAL 7040 Grey RAL 7040		
			€	Pz x conf Pcs box-bag	MOQ
11.23.160.02	12	6,5	-	2000	2000

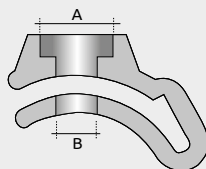

Supporto con aggancio per rete elettrosaldata
Support with hook for electrowelded net

SAGE

Codice Code	A	B	C	D	E	Grigio RAL 7040 Grey RAL 7040		
						€	Pz x conf Pcs box-bag	MOQ
11.23.161.02	48	34	25	12	7,5	-	2000	2000

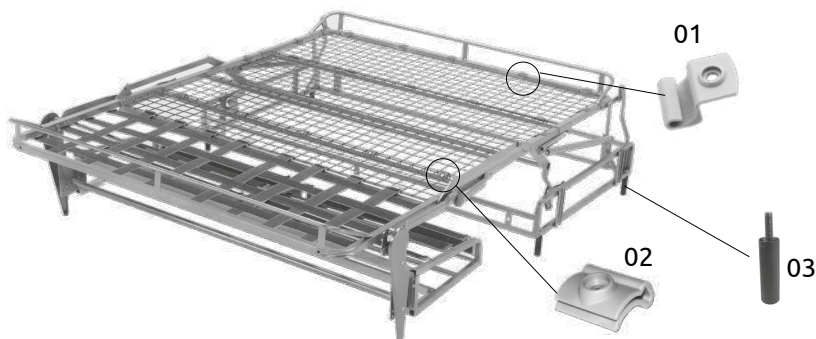
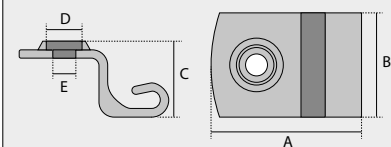

01	SAGE	Supporto con aggancio per rete elettrosaldata Support with hook for electrowelded net	pg. 85
02	SARE	Supporto ad arco per rete elettrosaldata Arched support for electrowelded net	pg. 84
03	PPML	Piedino per meccanismo letto Adjustable foot for bed mechanism	pg. 133

Copricerniere per reti letto
Hinge cover for bed frames

CRL

Codice Code		A	B	C	D	E	F	G	Grigio RAL 7040 Grey RAL 7040		
									€	Pz x conf Pcs box-bag	MOQ
11.23.111.02	25x5 (1 foro)	28.4	35	20	25.6	8.6	11.4	-	-	-	-
11.23.112.02	30x5 (2 fori)	31.8	39.5	17	31.8	8.6	11.4	9	-	4000	4000

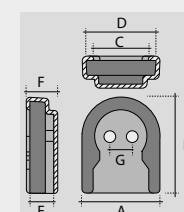
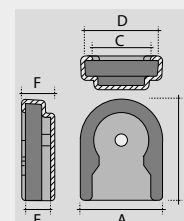
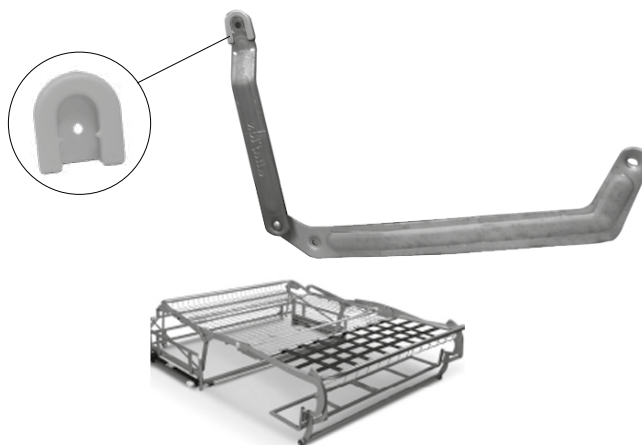

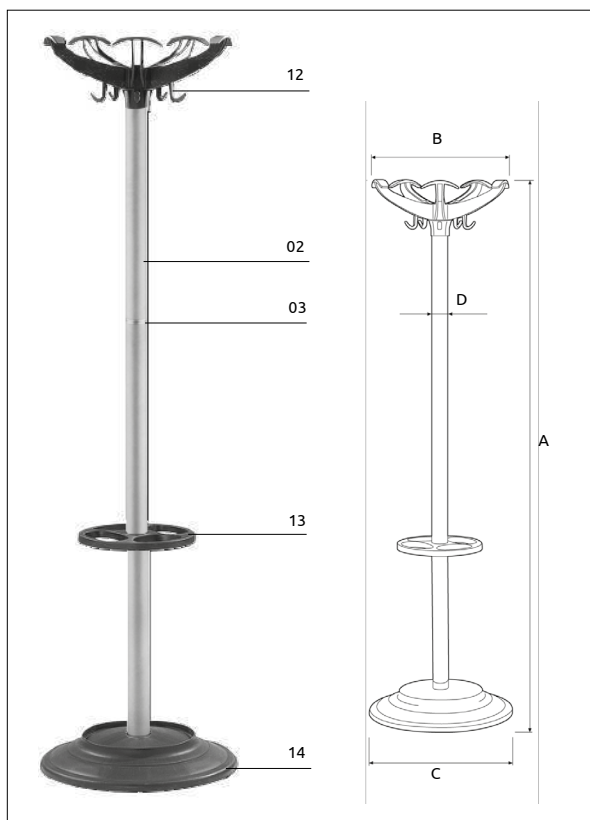
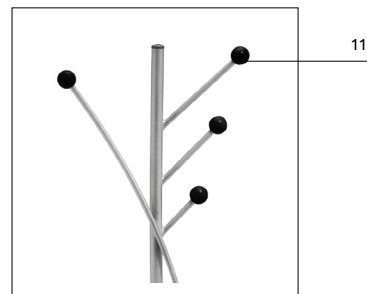
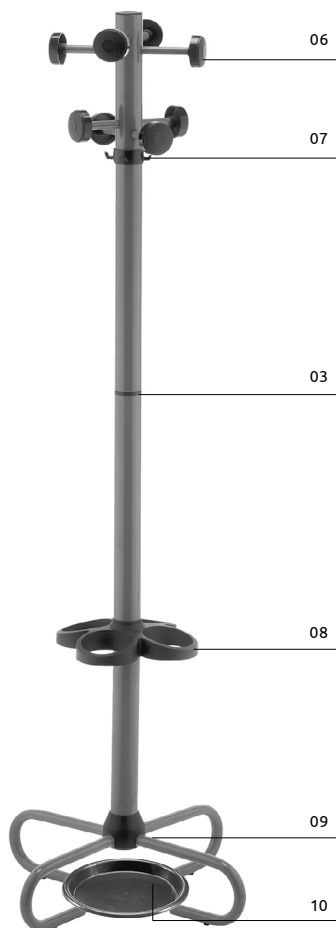
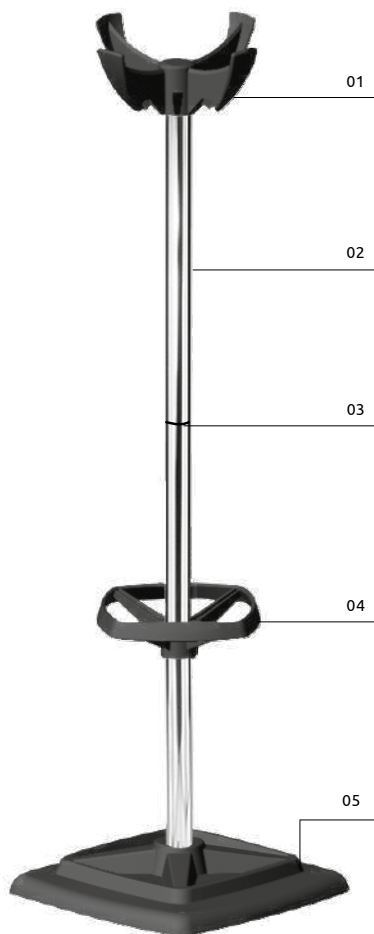







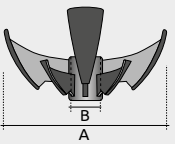

01	HA01	Appendino 4 posti TREE Coat hanger 4 places TREE	pg.87
02	-	Tubo fornito solo nel kit APEL Tube supplied only in the kit vers. APEL	-
03	ITRV+AXA+ITR	Innesto c vite per tubi rotondi in PS+Anello per appendiabiti in PP +Innesto c vite per tubi rotondi in PS Connector with screw for round tube+ Ring for stand coat hanger in PP+Connector with screw for round tube	pg.89
03*	ITR(x2)+VIT	Innesto per tubi rotondi filettato in PA +Vite per innesti ITR in FE zincocromato Threaded connector for round tube in PA(x2) + Zinc plated screw for connectors ITR	pg.90
03**	GGA	Giunto girevole per attaccapanni in PS Turning joint in PS	pg.90
04	DU01	Disco porta ombrelli TREE Umbrella stand plate TREE	pg.91
05	PU01	Base portaombrelli TREE Umbrella stand base TREE	pg.92
06	PPS	Pomolo per appendiabito in ABS Knob for coat hanger in ABS	pg.88
07	AP4	Appendino a 4 posti Ø50 Coat hanger 4 places Ø50	pg.87
08	DPOC	Disco portaombrelli 4 posti -PP Umbrella stand plate 4 places -PP	pg.91
09	CSA	Coprisaldatura per appendiabito Welding cover	pg.91
10	BPO	Bacinella portaombrelli rotonda in PP Round umbrella basin in PP	pg.92
11	PAP	Pomello per attaccapanni in ABS- Ball knob in ABS	pg.88
12	APP+MXA	Supporto Appendiabiti+ Mozzo per appendiabiti con copertina Coat-hook support+ Coat-hook with cover	pg.87
13	DPO	Disco portaombrelli 4 posti in PP Umbrella stand plate 4 places	pg.91
14	PORB	Base portaombrelli Umbrella-stand base	pg.92

Kit APEL appendiabito mod.Elix (12+02+03+13+14)

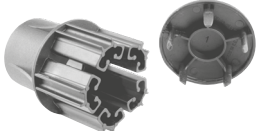
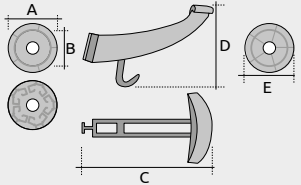
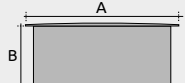
Appendiabiti a colonna con portaombrelli modello Elix
Coat-hangers with umbrella-stand model Elix

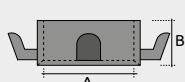
Code	A	B	C	D	NOTE
21.24.223.00N	1730	400	455	Ø50	nero black
21.24.223.00C	1730	400	455	Ø50	cromato chromed plated

					Appendino 4 posti TREE Coat hanger 4 places TREE			HA01
Codice Code	A	B	Nero Black					
			€	Pz x conf Pcs box-bag	MOQ			
11.24.246.02	300	Ø50	-	30	500		Im. pg. 86	
					Supporto appendiabiti Coat hanger hook support			APP
Codice Code	A	B	C	D	Nero Black			
					€	Pz x conf Pcs box-bag	MOQ	
11.24.220.05	74	Ø50	190	15	-	100	100	
					Mozzo per appendiabiti con copertina Coat hanger hook with cover			MXA
Codice Code	E	Nero Black						
		€	Pz x conf Pcs box-bag	MOQ				
11.24.221.05	75	-	100	100				
					Copriforo tubo Ø50 spess.1 mm per appendiabito Cover cap tube Ø50 for coat hanger			CPA
Codice Code	ØA	ØB	S. T.	Nero Black				
				€	Pz x conf Pcs box-bag	MOQ		
11.24.245.02	50	20	1	-	500	500		
					Appendino a 4 posti Ø50 Coat hanger 4 places Ø50			AP4
Codice Code	ØA	ØB	Nero Black					
			€	Pz x conf Pcs box-bag	MOQ			
11.24.218.02	50	24	-	500	500		Im. pg. 86	

INDEX

PFS

Pomelli attaccapanni in ABS
Ball knobs in ABS

	Codice Code	A	B	Nero Black			Cromato Chrome plated		
				€	Pz x conf Pcs box-bag	MOQ	€	Pz x conf Pcs box-bag	MOQ
	21.24.140.00	20	10MA	-	500	500	-	500	500
	21.24.141.00	28	10MA	-	200	200	-	200	200
	21.24.142.00	35	10MA	-	100	200	-	100	200
	21.24.143.00	44	10MA	-	100	200	-	100	200
	21.24.144.00	54	10MA	-	50	200	-	50	200
	21.24.145.00	64	10MA	-	50	200	-	50	200
	21.24.150.00	20	8MA	-	500	500	-	500	500
	21.24.151.00	28	8MA	-	200	200	-	200	200
	21.24.152.00	35	8MA	-	100	200	-	100	200
	21.24.153.00	44	8MA	-	100	200	-	100	200
	21.24.154.00	54	8MA	-	50	200	-	50	200
	21.24.155.00	64	8MA	-	50	200	-	50	200

PAP

Pomelli attaccapanni in ABS
Ball knobs in ABS

	Codice Code	ØA	ØB	Nero Black			Cromato Chrome plated		
				€	Pz x conf Pcs box-bag	MOQ	€	Pz x conf Pcs box-bag	MOQ
	21.24.120.00	64	25	-	50	200	-	50	200

PPS

Pomolo per appendiabito in ABS
Knob for cloth hanger in ABS

	Codice Code	A	B	Nero Black		
				€	Pz x conf Pcs box-bag	MOQ
Im. pg. 86	11.24.160.04	65	16	-	800	800

PATC



Pomelli attaccapanni neri-PS, testa FE cromata
Black knobs-PS-FE chromed head

	Codice Code	ØA	ØB	C	Nero testa in FE Black chromed head		
					€	Pz x conf Pcs box-bag	MOQ
	11.24.188.53	50	16	39	-	250	1500
	11.24.189.53	50	18	39	-	250	1500
	11.24.190.53	50	20	39	-	250	1500

INDEX

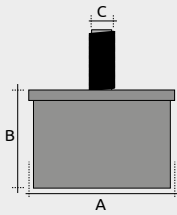

Innesto c|vite per tubi rotondi in PS
Connector with screw for round tube

ITRV

Codice Code	ØA	ØB	C	S. T.	Nero Black			
					€	Pz x conf Pcs box-bag	MOQ	
11.24.217.76	50	34	8MA	1	-	300	600	

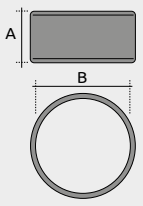

Anello per appendiabiti in PP
Ring for stand coat hanger in PP

AXA

Codice Code	A	B	Nero Black			
			€	Pz x conf Pcs box-bag	MOQ	
11.24.244.02	27	50	-	500	500	

Innesto c|vite per tubi rotondi in PS
Connector with screw for round tube

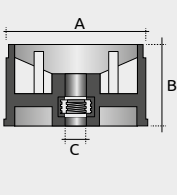
ITR

Codice Code	ØA	ØB	C	S. T.	Nero Black			
					€	Pz x conf Pcs box-bag	MOQ	
11.24.209.76	35	29	8MA	1	-	500	1000	
21.24.210.00	40	32	8MA	1	-	100	400	
11.24.211.76	50	34	8MA	1	-	600	3000	
21.24.212.00	60	34	8MA	1	-	50	400	

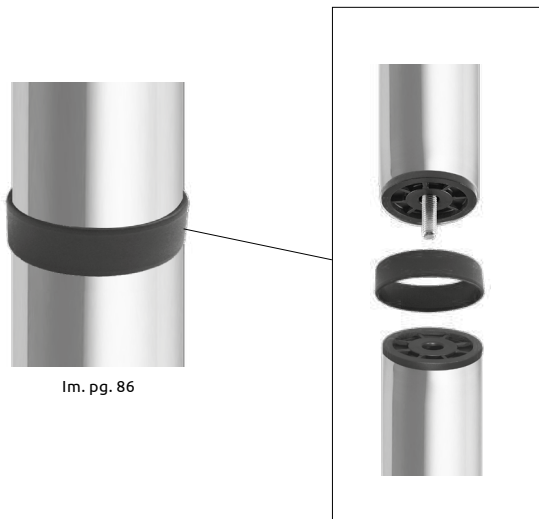

Im. pg. 86



ITRV

AXA

ITR

INDEX

ITR

Innesto per tubi rotondi filetta o in PA
Threaded connector for round tube in PA



Im. pg. 86

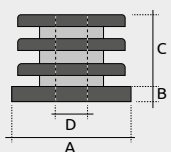

Codice Code	ØA	B	C	D	S.T.	Nero Black		
						€	Pz x conf Pcs box-bag	MOQ
11.24.208.05	30	4	19,5	8MA	1,2	-	1000	1000

VIT

Vite per innesti ITR in FE zincocromato
Zinc plated screw for connectors ITR



Im. pg. 86

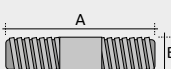

Codice Code	A	B	FE zincocromato Zinc plated		
			€	Pz x conf Pcs box-bag	MOQ
21.24.219.00	40	8MA	-	200	200

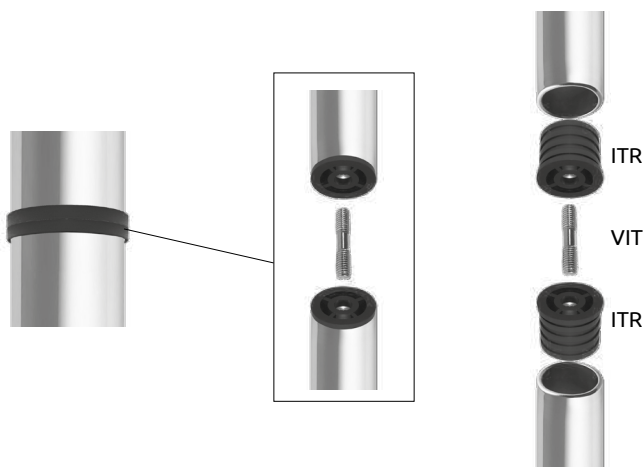

GGA

Giunto girevole per attaccapanni in PS
Turning joint in PS



Im. pg. 86

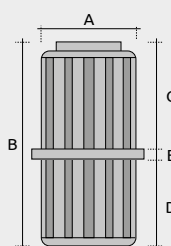

Codice Code	ØA	B	C	D	E	Nero Black		
						€	Pz x conf Pcs box-bag	MOQ
11.24.229.03	50	95	50	39	6	-	200	600

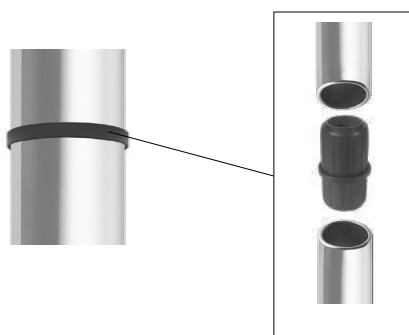

Disco porta ombrelli a 4 posti in PP
Umbrella-stand plate with 4 places in PP

DPO

Codice Code	A	B	Nero Black				
			€	Pz x conf Pcs box-bag	MOQ		
11.24.231.02	Ø268	Ø50	-	100	100		Im. pg. 86

Disco porta ombrelli a 4 posti in PP
Umbrella-stand plate with 4 places in PP

DPOQ

Codice Code	A	B	Nero Black				
			€	Pz x conf Pcs box-bag	MOQ		
11.24.233.02	305	Ø50-60	-	25	500		Im. pg. 86

Disco porta ombrelli a 4 posti in PP
Umbrella-stand plate with 4 places in PP

DPOC

Codice Code	A	B	Nero Black				
			€	Pz x conf Pcs box-bag	MOQ		
11.24.234.02	276	Ø50	-	50	500		Im. pg. 86

Disco porta ombrelli TREE
Umbrella-stand plate TREE

DU01

Codice Code	A	B	Nero Black				
			€	Pz x conf Pcs box-bag	MOQ		
11.24.248.02	250	Ø50	-	15	500		Im. pg. 86

Coprisaldatura per appendiabito
Welding cover for coat hanger

CSA

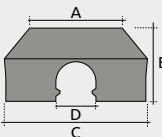
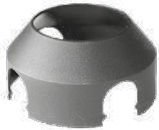
Codice Code	A	B	C	D	Nero Black				
					€	Pz x conf Pcs box-bag	MOQ		
11.24.236.02	50	42	80	22	-	500	1000		
11.24.237.02	50	60	80	22	-	250	250		

INDEX

BPO

Bacinelle portaombrelli rotonde in PP
Round umbrella-stand basins in PP

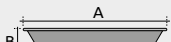
		Codice Code	ØA	B	Nero Black		
					€	Pz x conf Pcs box-bag	MOQ
Im. pg. 86		11.24.125.02	130	35	-	100	500
		11.24.126.02	200	35	-	100	1000

BPO

Bacinelle portaombrelli rotonde in PP
Round umbrella-stand basins in PP

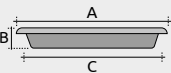
		Codice Code	ØA	B	C	Nero Black		
						€	Pz x conf Pcs box-bag	MOQ
Im. pg. 86		11.24.127.02	275	35	249	-	100	100

BPO

Bacinelle portaombrelli ovali in PP
Oval umbrella-stand basins in PP

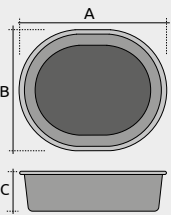
		Codice Code	A	B	C	Nero Black		
						€	Pz x conf Pcs box-bag	MOQ
		11.24.131.02	160	130	45	-	100	500

PU01

Base portaombrelli TREE
Umbrella-stand base Tree

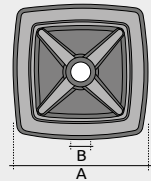
		Codice Code	A	B	Nero Black		
					€	Pz x conf Pcs box-bag	MOQ
Im. pg. 86		11.26.187.02	400	Ø50	-	210	500

PORB

Base portaombrelli
Umbrella-stand base

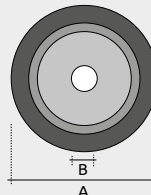
		Codice Code	A	B	Nero Black		
					€	Pz x conf Pcs box-bag	MOQ
Im. pg. 86		11.26.186.02	450	Ø50	-	150	150

Appendiabito a muro TREE
Coat hook tree

HM01

Codice Code	A	B	C	D	Nero grigio RAL7040 Black grey RAL7040			Verde ice, blu ice e arancio ice Transparent green, transparent blue, transparent orange		
					€	Pz x conf Pcs box-bag	MOQ	€	Pz x conf Pcs box-bag	MOQ
11.24.247.02	120	64	32	84	-	200	1000	-	200	1000



Im. pg. 99

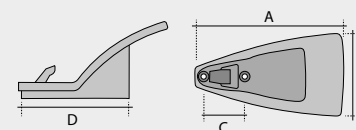

Attaccapanni rigido in PP
Rigid coat stand in PP

AO2

Codice Code	A	B	C	D	E	Nero, bianco RAL9003, blu RAL5015, rosso RAL3002, giallo RAL1016, verde RAL6032 Black, white RAL9003, blue RAL5015, red RAL3002, yellow RAL1016, green RAL6032			Altri colori Other colours		
						€	Pz x conf Pcs box-bag	MOQ	€	Pz x conf Pcs box-bag	MOQ
11.24.102.02	117	80	32	34	84	-	300	300	-	300	2100

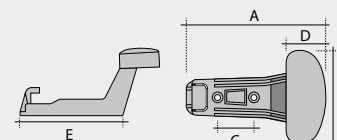

Attaccapanni ovale in PP
Oval coat stand in PP

AO



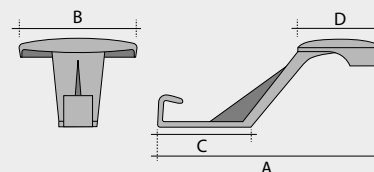

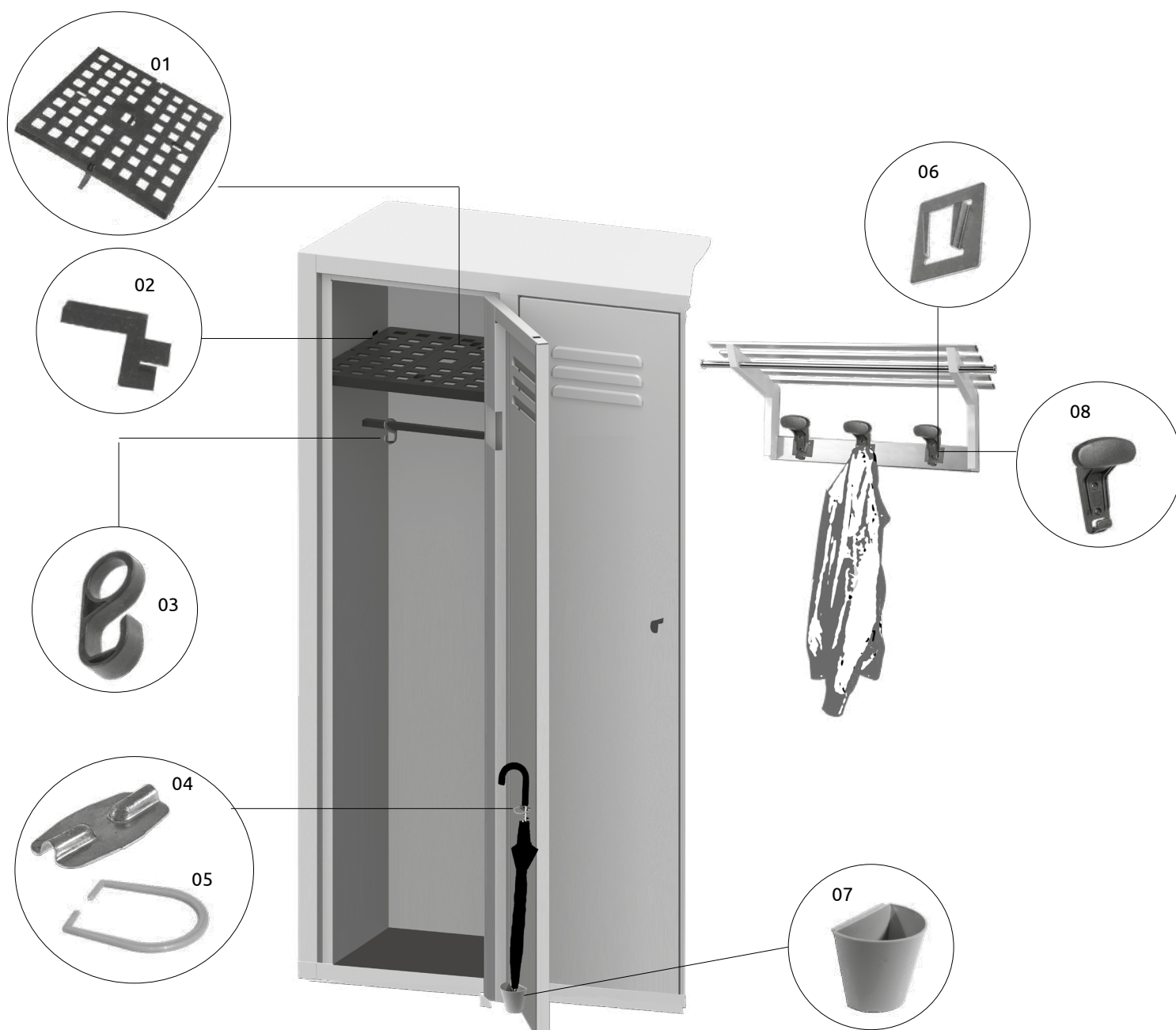



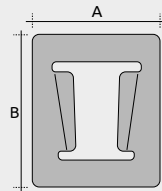

Codice Code	A	B	C	D	Nero, Giallo RAL 1016 Black, Yellow RAL 1016			Rosso RAL3002, Verde RAL 6032 Red RAL 3002, Green RAL 6032			Altri colori Other colours		
					€	Pz x conf Pcs /box- bag	MOQ	€	Pz x conf Pcs /box- bag	MOQ	€	Pz x conf Pcs /box- bag	MOQ
11.24.101.02	131	98	55	56,5	-	300	300	-	300	600	-	300	2100

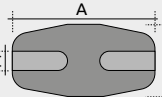

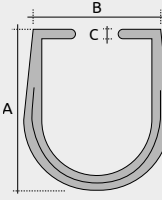

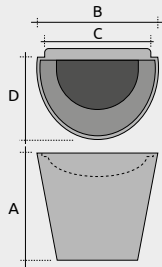
01	GAS-GASD	Griglia per armadietti spogliatoio con appendino in PST Grid for lockers with coat hanger in PST	pg. 96
02	GRA	Gancetto reggipiani per armadietti Shelf hook for locker	pg. 96
03	GPG	Gancio porta-giacca in PA Hook for jacket in PA	pg. 95
04	PGO	Piastra per GPO spogliatoi in FE grezzo Raw FE plate for umbrella-stand	pg. 95
05	GPO	Gancio reggi ombrello spogliatoi in PP Umbrella-stand in PP	pg. 95
06	PAS	Piastra aggancio attaccapanni spogliatoio in FE cromato Chrome FE plate for coat hanger	pg. 95
07	VPO	Vaschetta porta ombrelli per spogliatoi in PP Umbrella-trayer in PP	pg. 95
08	AO	Attaccapanni ovale in PP Oval coat stand in PP	pg. 93

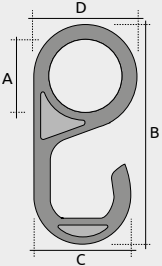
INDEX

Piastra aggancio attaccapanni spogliatoio in FE cromato Chrome FE plate for coat hanger							PAS		
Codice Code	A	B	FE cromato Chrome plated FE						
			€	Pz x conf Pcs box-bag	MOQ				
11.26.174.67	55	65	-	500	1000		Im. pg. 94		
Piastra per GPO spogliatoi in FE grezzo Raw FE plate for umbrella-stand							PGO		
Codice Code	A	B	C	FE grezzo Raw FE					
				€	Pz x conf Pcs box-bag	MOQ			
11.26.175.67	57	29,5	5,5	-	500	1000	Im. pg. 94		
Gancio reggi ombrello spogliatoi in PP Umbrella-stand in PP							GPO		
Codice Code	A	B	ØC	Grigio Grey					
				€	Pz x conf Pcs box-bag	MOQ			
11.26.176.02	97	75	5	-	500	500	Im. pg. 94		
Vaschetta porta ombrelli per spogliatoi in PP Umbrella-tray in PP							VPO		
Codice Code	A	B	C	D	Grigio Grey				
					€	Pz x conf Pcs box-bag	MOQ		
11.26.173.02	59	67	58,5	48	-	500	500	Im. pg. 94	
Gancio porta-giacca in PA Hook for jacket in PA							GPG		
Codice Code	A	B	C	D	Nero Black				
					€	Pz x conf Pcs box-bag	MOQ		
11.26.190.05	18,5	54,5	24	26	-	1000	3000	Im. pg. 94	

INDEX

GRA

Gancetto reggipiani per armadietti
Shelf hook for locker



Im. pg. 94

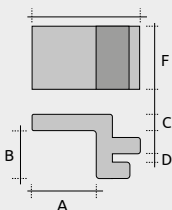

Codice Code	A	B	C	D	E	F	Nero Black		
							€	Pz x conf Pcs box-bag	MOQ
11.26.191.05	9,5	7	2,5	1	16	9	-	5000	10000

GAS

Griglia per armadietti spogliatoio con appendino in PST
Grid for lockers with coat hanger in PST

Codice Code	A	B	C	D	Nero Black		
					€	Pz x conf Pcs box-bag	MOQ
11.26.194.03	300	324	16	86	-	20	1000

GASD

Griglia per armadietti spogliatoio con appendino in PST
Grid for locker with coat hanger in PST

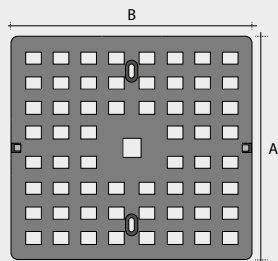
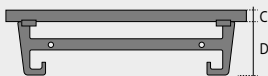

Im. pg. 94

Codice Code	A	B	C	D	Nero Black		
					€	Pz x conf Pcs box-bag	MOQ
11.26.193.03	300	354	16	86	-	20	1000

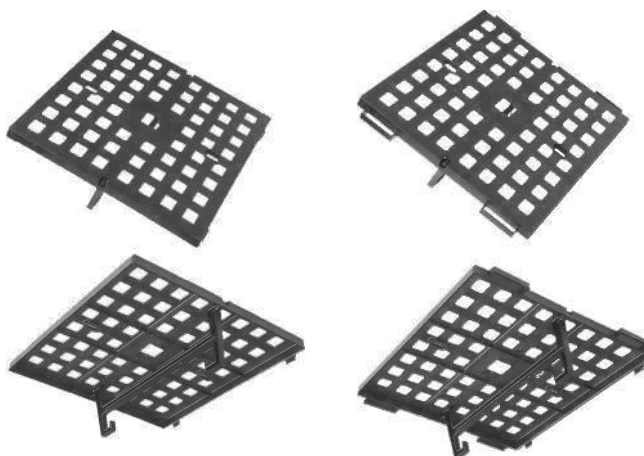

Ventose con gambo forato in PVC
Buffers with drilled bolt in P C

VG

Codice Code	ØA	B	C	ØD	Trasparente Transparent			Nero Black			Bianco White		
					€	Pz x conf Pcs box-bag	MOQ	€	Pz x conf Pcs box-bag	MOQ	€	Pz x conf Pcs box-bag	MOQ
11.25.101.01	15	10	4	6	-	5000	5000	-	5000	50000	-	5000	50000
11.25.102.01	20	8,5	6,5	6	-	5000	5000	-	5000	50000	-	5000	50000

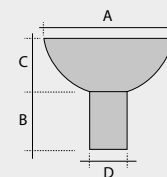

Ventose con sfera in PVC
Buffers with ball in P C

VS

Codice Code	ØA	B	C	ØD	Trasparente Transparent			Nero Black			Bianco White		
					€	Pz x conf Pcs box-bag	MOQ	€	Pz x conf Pcs box-bag	MOQ	€	Pz x conf Pcs box-bag	MOQ
11.25.105.01	20	10	4	6	-	5000	5000	-	5000	50000	-	5000	50000
11.25.106.01	25	12	5	7	-	5000	5000	-	5000	50000	-	5000	50000
11.25.107.01	30	13	6	8	-	5000	5000	-	5000	50000	-	5000	50000

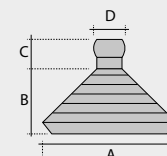

Riduttore alettato in PE per rotelle
PE adapters for castors

RR

Codice Code	Tubo esterno Ext tube size	ØA	ØB	C	S.T.	Nero Black		
						€	Pz x conf Pcs box-bag	MOQ
11.25.111.02	14	12	8	24	1	-	2000	4000
11.25.112.02	16	14	8	24	1	-	1500	1500
11.25.113.02	18	16	8	24	1	-	1500	4500
11.25.114.02	20	18	8	24	1	-	1500	1500
11.25.115.02	22	20	8	24	1	-	1000	1000
11.25.116.02	25	23	8	24	1	-	1000	1000
11.25.117.02	28	26	8	24	1	-	1000	3000

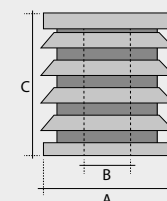

3R

Riduttori rigati per ruote in PP
Striped adapter for castors in PP

NEW*

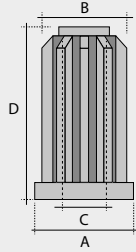

Codice Code	ØA	ØB	S. T.	ØC	D	Nero Black		
						€	Pz x conf Pcs box-bag	MOQ
11.25.190.02	20	17	1,5	10	34	-	2000	2000
11.25.191.02	20	17	1,5	11	34	-	2000	2000
-	22	17	2,5	10	34	-	2000	2000
11.25.198.02*	22	17	2,5	11	34	-	2000	2000
11.25.196.02	22	18	2,0	10	34	-	2000	4000
11.25.197.02	22	18	2,0	11	34	-	2000	4000
11.25.127.02	22	19	1,5	10	34	-	2000	6000
11.25.128.02	22	19	1,5	11	34	-	2000	4000
11.25.188.02	25	21	2,0	10	34	-	2000	2000
11.25.189.02	25	21	2,0	11	34	-	2000	2000
11.25.192.02	25	22	1,5	10	34	-	2000	2000
11.25.193.02	25	22	1,2-1,5	11	34	-	2000	2000
11.25.194.02	28	25	1,5	10	34	-	1500	1500
11.25.195.02	28	25	1,5	11	34	-	1500	1500

RML

Riduttore per perno godronato in PP
Reducer for knurled pin in PP

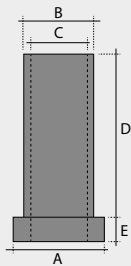

Codice Code	A	B	C	D	E	Nero Black		
						€	Pz x conf Pcs box-bag	MOQ
11.25.185.02	13	10	8	23	3,5	-	2000	10000

RBV

Riduttore per bloccaggio viti in PE
PE adapter for screws locking of screws

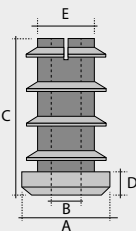

Codice Code	A	B	C	D	E	ST TT	Nero Black			Colorato a richiesta Coloured version on demand		
							€	Pz x conf Pcs box-bag	MOQ	€	Pz x conf Pcs box-bag	MOQ
11.25.177.02	Ø14	Ø8	27	5	Ø8	1	-	4000	4000	-	-	-
11.25.178.02	Ø16	Ø8	27	5	Ø10	1	-	4000	4000	-	-	-
11.25.179.02	Ø18	Ø8	27	5	Ø12	1	-	4000	4000	-	-	-

FCV

Fermacrystalli-vite in FE-testa cromata o ottonata
Glass blocking -FE screws-head chromed|brassed

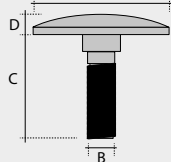

Codice Code	ØA	ØB	C	D	Nero Black			Cromato Chrome plated		
					€	Pz x conf Pcs box-bag	MOQ	€	Pz x conf Pcs box-bag	MOQ
21.25.240.00	35	8	26	5	-	100	400	-	100	400
21.25.241.00	50	8	26	5	-	50	400	-	50	400
21.25.242.00	60	8	26	5	-	50	300	-	50	300

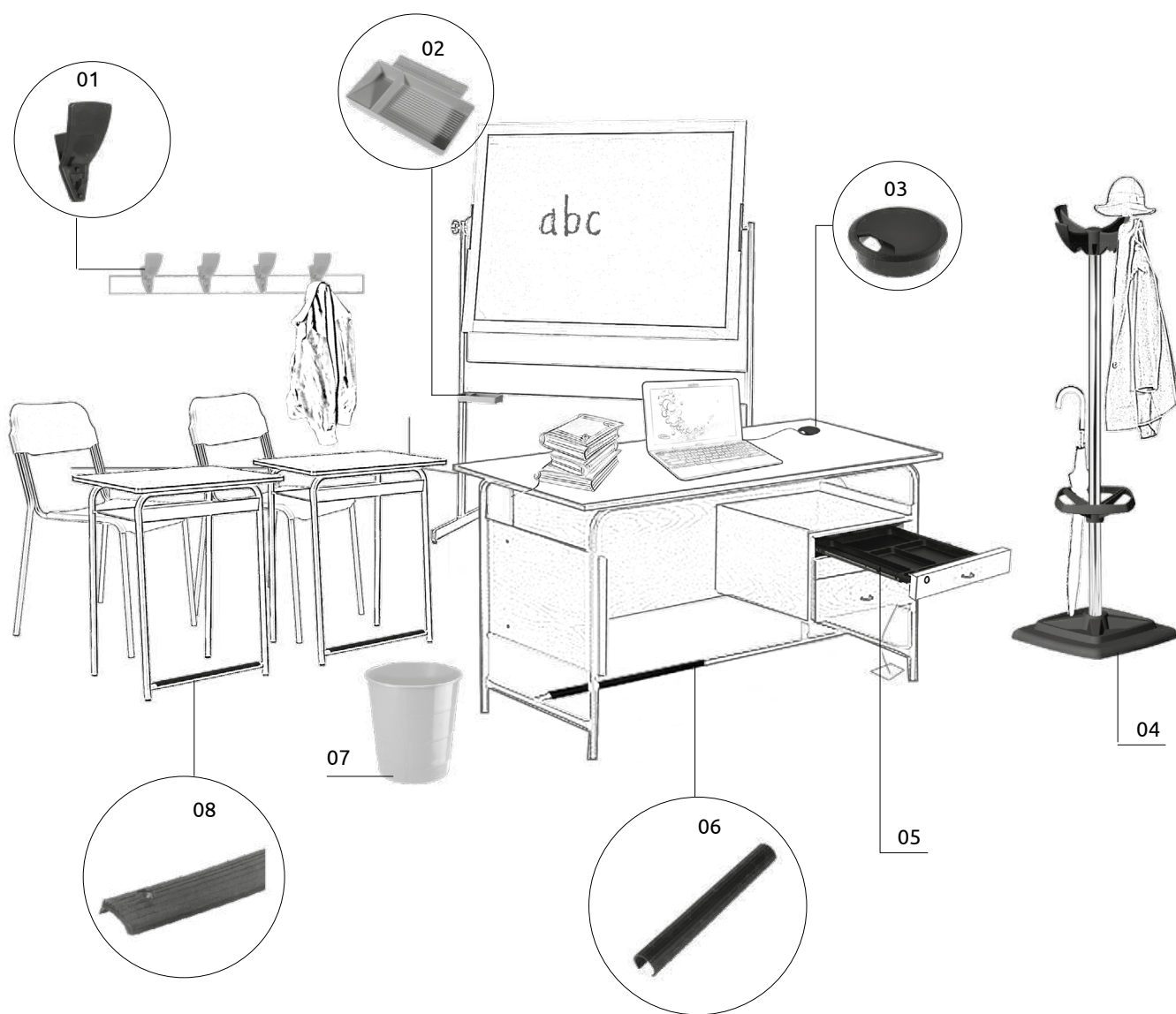

01	HM01	Appendiabito a muro TREE Coat hook tree	pg. 93
02	VLG	Vaschetta lavagna porta gesso in PP Chalk tray in PP	pg. 100
03	PCS	Passacavo per scrivania in PS Grommet for desk in PS	pg. 101
04	TREE	Appendiabiti a colonna TREE Clothes-hanger with umbrella-stand TREE	pg. 86
05	-	Cassetto portaoggetti Object tray	pg. 108
06	PPG	Profila o rotondo in PVC rigido Profile overs in rigid PVC	pg. 100
07	CESG	Cestino getta carta in PP Paper basket in PP	pg. 110
08	PGP	Poggiapiedi in PE con fori svasati per viti Foot-rest with holes for screws in PE	pg. 100

INDEX

PGP

Poggiapiedi in PE con fori svasati per viti
Foot-rest with holes for screws in PE



Im. pg. 99

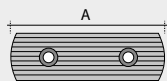

Codice Code	ØTubo ØTube	Lunghezza A Lengh A	Nero Black		
			€	Pz x conf Pcs box-bag	MOQ
11.26.101.02	14 a 16	330	-	300	300
11.26.102.02	24 a 28	320	-	300	300
11.26.103.02	24 a 28	400	-	300	300
11.26.104.02	24 a 28	500	-	300	300

VLG

Vaschetta lavagna porta gesso in PP
Chalk tray in PP



Im. pg. 99

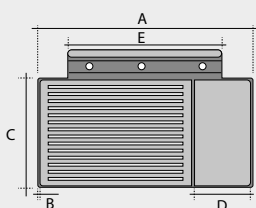

Codice Code	A	B	C	D	E	Grigio Grey		
						€	Pz x conf Pcs box-bag	MOQ
11.26.108.02	192	186	98	50	137	-	50	100

PPG

Profilo rotondo in PVC rigido
Profile overs in rigid PVC



Im. pg. 99

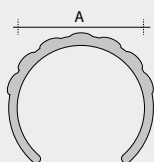

Codice Code	ØA	Nero Black			Grigio Grey		
		€	Pz x conf Pcs box-bag	MOQ	€	Pz x conf Pcs box-bag	MOQ
21.26.200.00	10	-	200m	200m	-	200m	200m
21.26.201.00	12	-	200m	200m	-	200m	200m
21.26.202.00	14	-	200m	200m	-	200m	200m
21.26.203.00	16	-	150m	150m	-	150m	150m
21.26.204.00	18	-	100m	100m	-	100m	100m
21.26.205.00	20	-	100m	100m	-	100m	100m
21.26.206.00	22	-	100m	100m	-	100m	100m
21.26.207.00	25	-	100m	100m	-	100m	100m
21.26.208.00	28	-	50m	50m	-	50m	50m
21.26.209.00	30	-	50m	50m	-	50m	50m
21.26.210.00	35	-	50m	50m	-	50m	50m

Profilato poggiapiedi a pinza in PVC rigido. Colore nero o grigio, in verghe da mt.2.
Si possono fornire verghe tagliate a misura con costo di €0,10 al taglio.

Bar of 2 meters length colour black or grey, different sizes are on request at cost of €0,10 each cut.

Profilo a quadro e rettangolare-PVC rigido
Rectangular and square cover profile-rigid P C

PQR

Codice Code	A	B	Nero Black			Grigio Grey		
			€/m	Pz x conf Pcs box-bag	MOQ	€/m	Pz x conf Pcs box-bag	MOQ
21.26.220.00	20	20	-	100m	100m	-	100m	100m
21.26.221.00	25	25	-	64m	64m	-	64m	64m
21.26.222.00	30	30	-	64m	64m	-	64m	64m
21.26.223.00	40	20	-	48m	48m	-	48m	48m

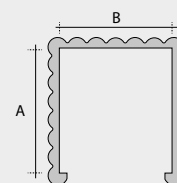
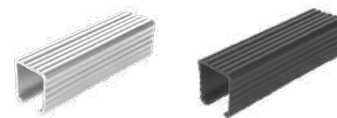

Profilato poggiaiedi a pinza in PVC rigido.
Colore nero o grigio, in verghe da mt.2. Si possono fornire verghe tagliate a misura con costo di €.0,10 al taglio.

Bar of 2 meters length colour black or grey, different sizes are on request at cost of €.0,10 each cut

Passacavo per scrivania in PS
Cable ducts for desk in PS

PCS

Codice Code	A	B	C	D	Nero Black			Colorato a richiesta Coloured version on demand		
					€	Pz x conf Pcs box-bag	MOQ	€	Pz x conf Pcs box-bag	MOQ
11.26.180.03	72	60	3	21	-	250	250	-	-	-
11.26.181.03	91	80	4	21	-	75	75	-	-	-



Im. pg. 99

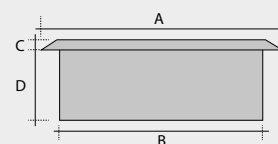

Cuscinetti a sfera in PA (Adatti per cassetti ecc.)
Ball bearing in PA (Suitable for drawers and etc.)

CSO

Codice Code	ØA	ØB	C	D	E	Neutro Neutral		
						€	Pz x conf Pcs box-bag	MOQ
21.26.131.00	23	6	8	8	7	-	1000	1000
21.26.132.00	25	6	8	8	7	-	1000	1000
21.26.133.00	28	6	8	8	7	-	1000	1000
21.26.134.00	30	6	8,5	10	7	-	1000	1000

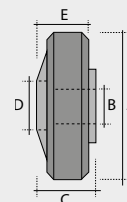

Cuscinetti per rivettatura a strappo in PA testa liscia (Adatti per cassetti ecc.)
Ball bearings in PA with smooth head (Suitable for drawers and etc.)

CSL

Codice Code	ØA	ØB	C	D	Neutro Neutral		
					€	Pz x conf Pcs box-bag	MOQ
21.26.112.00	23	5	7	10	-	1000	1000
21.26.113.00	25	5	7	10	-	1000	1000
21.26.114.00	28	5	7	10	-	1000	1000

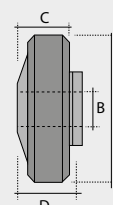

INDEX

CSS

Cuscinetti per rivettatura a strappo in PA (Adatti per cassetti ecc.)
Ball bearings in PA (Suitable for drawers and etc.)

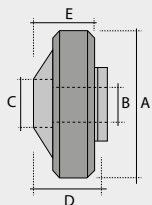

Codice Code	ØA	ØB	C	D	E	Neutro Neutral		
						€	Pz x conf Pcs box-bag	MOQ
21.26.165.00	23	5	12	12	8,5	-	1000	1000
21.26.166.00	25	5	12	12	8,5	-	1000	1000
21.26.167.00	28	5	12	12	8,5	-	1000	1000

VC

Vite per cuscinetti in FE zincato
Zinc plated screw for bearings

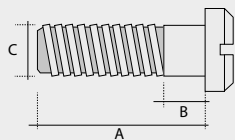

Codice Code	A	B	ØC	FE zincato Zinc plated		
				€	Pz x conf Pcs box-bag	MOQ
11.26.137.65	15	5	6	-	1000	1000

RC

Rotelle cassetti in PA (Adatti per cassetti ecc.)
Drawer castors in PA (Suitable for drawers and etc.)

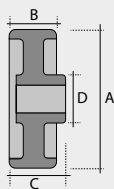

Codice Code	ØA	B	C	ØD	Neutro Neutral		
					€	Pz x conf Pcs box-bag	MOQ
11.26.140.05	27	10,5	11,5	8	-	1000	5000

INDEX

Perno per rotella RC in PA colore neutro
Pivot for castors in neutral PA

PR

Codice Code	A	B	C	ØD	ØE	Neutro Neutral		
						€	Pz x conf Pcs box-bag	MOQ
11.26.141.05	13	10	12	5	8	-	1000	5000

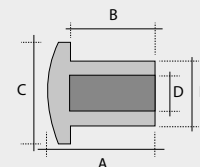

Mensola reggipiano in PA neutro
Shelf in neutral PA

MR

Codice Code	A	B	C	Neutro Neutral		
				€	Pz x conf Pcs box-bag	MOQ
11.26.127.05	21x24,5	3,5x15,5	9,5	-	2000	2000

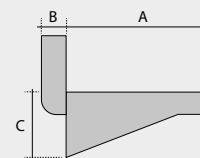

Staffa di fissaggio scrivani
Desk fixing bracket

SFS

Codice Code	A	B	C	D	E	F	G	H	I	L	M	N	Grigio Pantone 429C Grey Pantone 429C		
													€	Pz x conf Pcs box-bag	MOQ
11.26.255.05	90	76	30	30	30	10	5	48	36	36	20	10	-	500	500

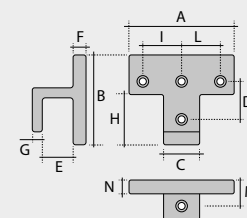
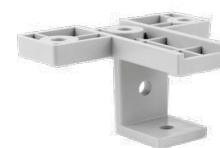

Pinza quadra per staffa di fissaggio
Square plier for bracket

PQS

Codice Code	A	B	C	D	E	F	Grigio Pantone 429C Grey Pantone 429C		
							€	Pz x conf Pcs box-bag	MOQ
11.26.256.05	20	42	36	30	21	10	-	500	500

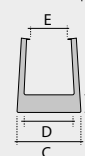
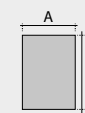

Portaoggetti regolabile per cassetto | Object tray for desk

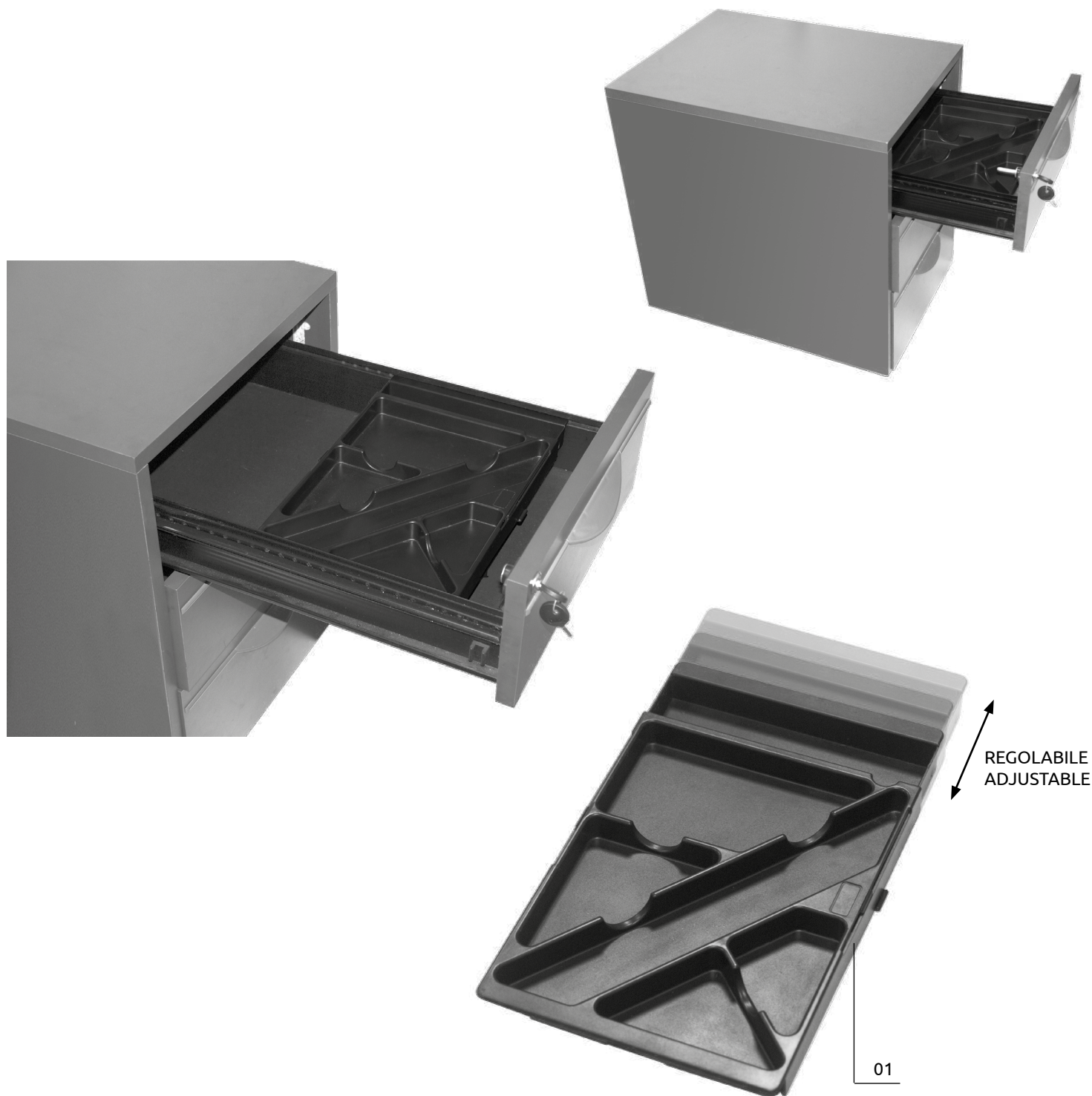

Porta oggetti cassetti scrivania in PS
Objects-trayer for desk in PS

POS

Codice Code	A	B	C	D	Nero Black		
					€	Pz x conf Pcs box-bag	MOQ
11.26.123.03	349	168	18	327	-	40	40

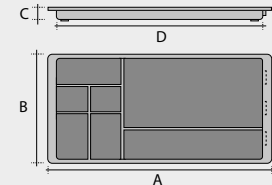
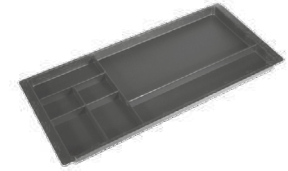

Porta oggetti cassetti scrivania con fermo in PS
Objects-trayer with blocking in PS

POSF

Codice Code	A	B	C	D	E	F	G	Nero Black		
								€	Pz x conf Pcs box-bag	MOQ
11.26.122.03	349	168	18	327	156	2	6,5	-	40	1000

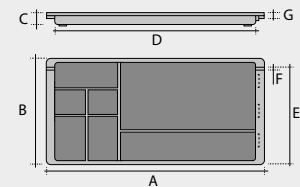
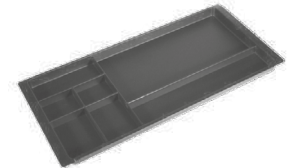

Porta oggetti cassetti scrivania in PS
Objects-trayer for desk in PS

POSL

Codice Code	A	B	C	D	E	F	Nero Black		
							€	Pz x conf Pcs box-bag	MOQ
11.26.121.03	349	168	18	327	342	363	-	40	500

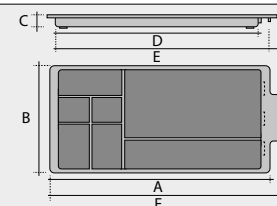
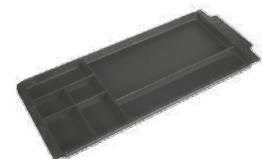

INDEX

POSG

Porta oggetti cassette scrivania in PS
Objects-trayer for desk in PS

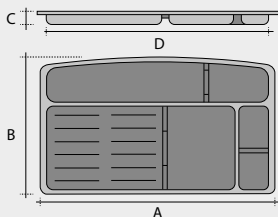

Codice Code	A	B	C	D	Nero Black		
					€	Pz x conf Pcs box-bag	MOQ
11.26.126.03	350	200	22	325	-	40	40

POSGF

Porta oggetti cassette scrivania in PS
Objects-trayer for desk in PS

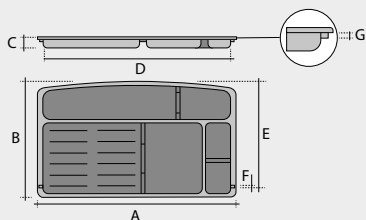

Codice Code	A	B	C	D	E	F	G	Nero Black		
								€	Pz x conf Pcs box-bag	MOQ
11.26.130.03	350	200	22	325	181	2,5	5,5	-	40	500

POSSL

Porta oggetti cassette scrivania in PS
Objects-trayer for desk in PS

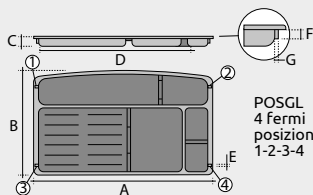

POSSL
4 Fermi
posizioni
1-2-3-4

Codice Code	A	B	C	D	E	F	G	Nero Black		
								€	Pz x conf Pcs box-bag	MOQ
11.26.135.03	350	200	22	325	2	8	2	-	40	40

Portaoggetti cassetti scrivania con fermo in PS
Objects-trayer with blocking in PS

POSGS

Codice Code	A	B	C	D	E	F	G	H	Nero Black		
									€	Pz x conf Pcs box-bag	MOQ
11.26.136.03	350	200	22	325	1,5	8	6	3	-	40	500

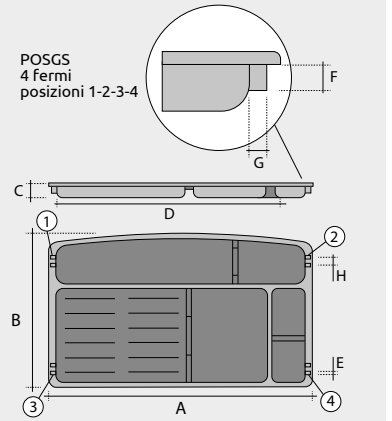

Portaoggetti con cassetto regolabile per scrivania
Objects-trayer with adjustable drawer for desk

POSR

Codice Code	A max	B min	C	D	E max	F min	Nero Black		
							€	Pz x conf Pcs box-bag	MOQ
11.26.124.03	451	327	223	28	417	293	-	20	20

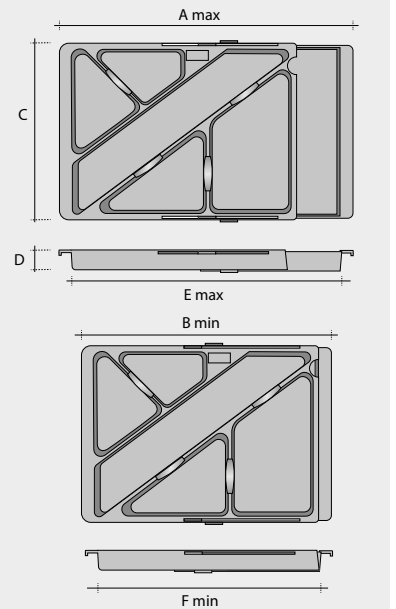

Cassetto portaoggetti | Object tray

Im. pg.109

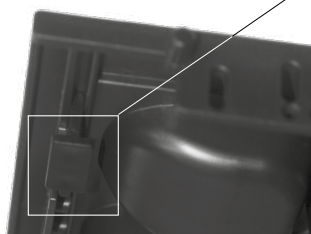
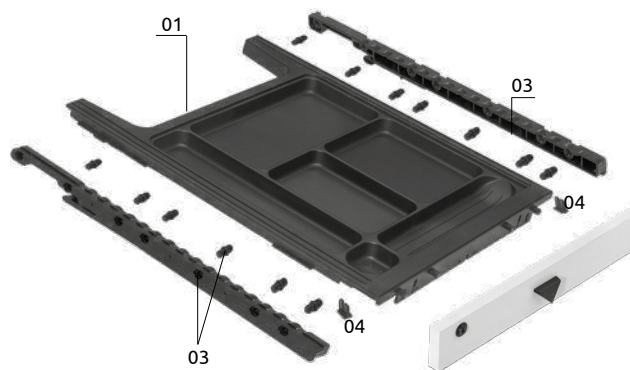
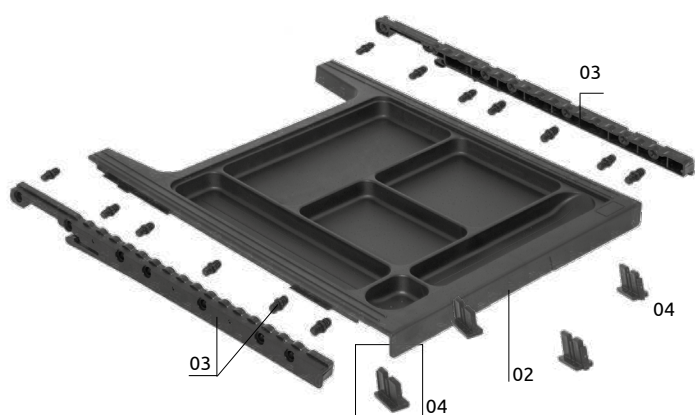

01	CPOP	Cassetto portaoggetti scorrevole con pioli nero Sliding object tray with pags-black	pg. 109
02	CPO	Cassetto portaoggetti scorrevole nero Sliding object tray -black	pg. 109
03	GCS	Cop.guide c pioli per cassetto scorrevole nero Pair of guides for object tray -black	pg. 109
04	FCPO	Fermo per cassetto portaoggetti Stop for objects trayer	pg. 109

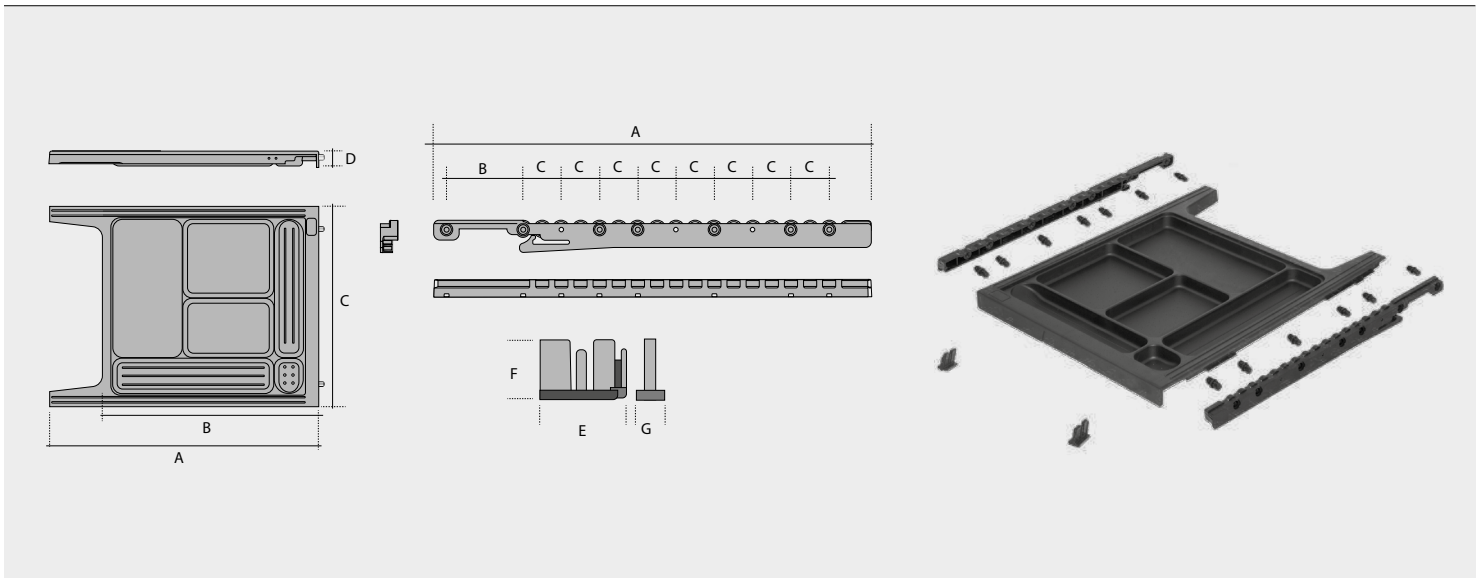

Cassetto portaoggetti scorrevole con pioli e fermo
Objects-trayer with pags with stop for objects tray

CPOP

Codice Code	A	B	C	D	Nero Black		
					€	Pz x conf Pcs box-bag	MOQ
11.26.230.03	500	400	370	30	-	20	20



Cassetto portaoggetti scorrevole e fermo*
Objects-trayer with stop for objects tray

CPO

Codice Code	A	B	C	D	Nero Black		
					€	Pz x conf Pcs box-bag	MOQ
11.26.231.03	500	400	370	30	-	20	20



Coppia guide con pioli per cassetto portaoggetti
Pair of guides for objects-trayer

GCS

Codice Code	A	B	C	Nero Black		
				€	Pz x conf Pcs box-bag	MOQ
11.26.232.03	365	64	32	-	40	40



	E	F	G			
*FERMO	28	19	13			

INDEX

CESG

Cestino getta carta in PP
Paper basket in PP



Im. pg. 99

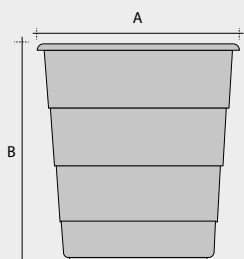

Codice Code	ØA	B	Nero Black			Colorato Different colours		
			€	Pz x conf Pcs box-bag	MOQ	€	Pz x conf Pcs box-bag	MOQ
19.12.150.02	295	315	-	30	30	-	30	510

PODI

Vaschetta portadocumenti impilabile
Stackable document tray

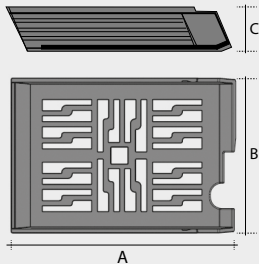

Codice Code	A	B	C	Nero Black		
				€	Pz x conf Pcs box-bag	MOQ
11.26.199.03	365	248	73	-	20	500



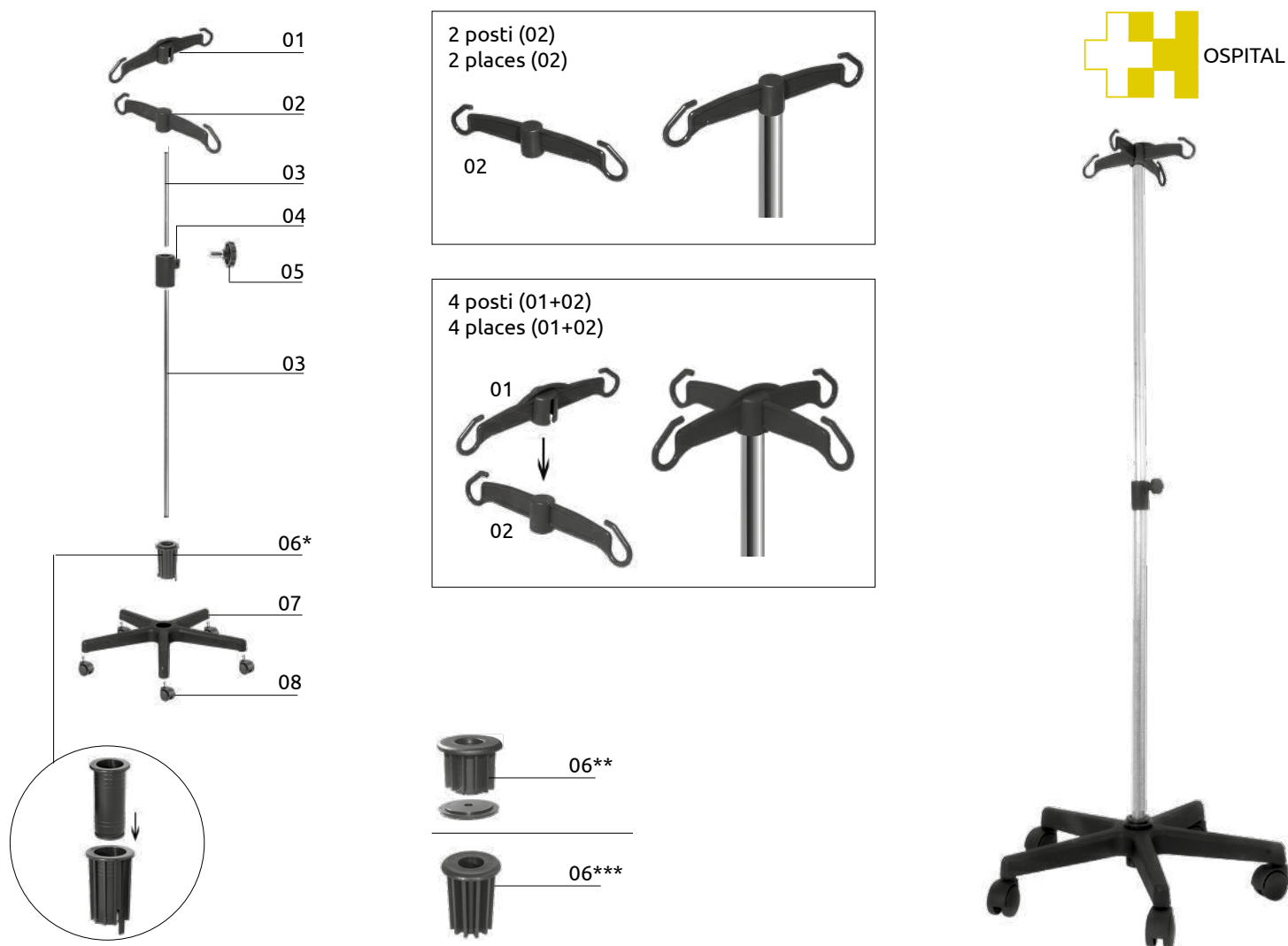

01	ASPF	ASPF	Attacco superiore porta flebo Top joint for drip trayer	pg. 112
02	APF2	APF2	Appendino porta flebo 2 posti Drip bag trayer 2 places	pg. 112
03	-	-	Tubo (non fornito) Tube (not supplied)	-
04	IPF	IPF	Innesto porta flebo Junction for medical drip bag trayer	pg. 112
05	11.41.151.40	VGF	Volantino con gambo filetta o in PS antiurto Star knob with threaded bolt	pg. 121
06*	21.30.001.00N 21.30.001.00N	RBSS	Riduzione per basi cono Ø50 con linguetta di smontaggio Reduction for base cone Ø50 with disassembling tongue	pg. 113
07	11.20.351.05N	BMS	Base mod. Svezia in nylon 30% FV Base model Svezia in nylon 30% FG	(vedi catalogo componenti) (See the Component catalogue)
08	11.25.307.80N4	DRG	Doppia ruota Ø50 in PA (roller) PA wheel castor Ø50 (roller)	pg. 151

*06 in alternativa

06**	11.20.440.02 11.20.441.02	RBS	Riduzione per basi cono Ø50 completa di ghiera Reduction for base cone Ø50 with ring included	pg. 113
06***	21.30.004.00N 21.30.006.00N	RBSL	Riduzione per basi cono Ø50 senza linguetta di smontaggio Reduction for base cone Ø50 with disassembling tongue	pg. 113

INDEX

IPF

Innesto porta fleb
Joint for drip bag trayer

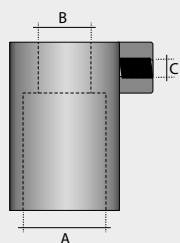

Codice Code	A	B	C	Nero Black			Colorato a richiesta Coloured version on demand		
				€	Pz x conf Pcs box-bag	MOQ	€	Pz x conf Pcs box-bag	MOQ
11.26.249.05	25	12	M8	-	300	300	-	-	-
11.26.245.05	25	16	M8	-	300	300	-	-	-
11.26.246.05	25	18	M8	-	300	300	-	-	-
11.26.247.05	28	16	M8	-	300	300	-	-	-
11.26.248.05	28	18	M8	-	300	1000	-	-	-

APF2

Appendino porta flebo 2 post
Drip bag trayer 2 places

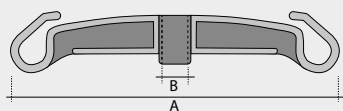

Codice Code	A	B	Nero Black			Colorato a richiesta Coloured version on demand		
			€	Pz x conf Pcs box-bag	MOQ	€	Pz x conf Pcs box-bag	MOQ
21.26.242.00	232	16	-	400	400	-	-	-
21.26.243.00	232	18	-	400	400	-	-	-

ASPF

Attacco superiore porta flebo 2 post
Drip bag trayer 2 places

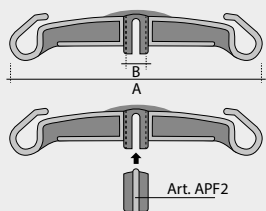
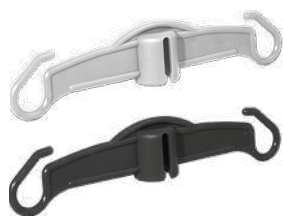

Codice Code	A	Nero Black			Colorato a richiesta Coloured version on demand		
		€	Pz x conf Pcs box-bag	MOQ	€	Pz x conf Pcs box-bag	MOQ
21.26.244.00	232	-	400	400	-	-	-

INDEX

Riduz. per basi cono Ø50 con di ghiera
Reduction for base cone Ø50 with ring

RBS

Codice Code	A	B	C	D	E	F	Nero Black		
							€	Pz x conf Pcs box-bag	MOQ
11.20.440.02	25	60	48	5	41	9	-	300	300
11.20.441.02	28	60	48	5	41	9	-	300	300

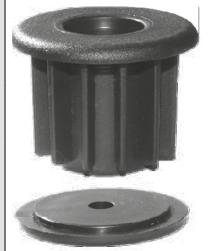
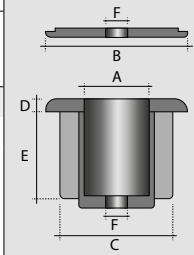

Riduzione per basi cono Ø50 con linguetta di smontaggio
Reduction for base cone Ø50 with disassembling tongue

RBSS

Codice Code	A	B	C	D	E	F	Nero Black		
							€	Pz x conf Pcs box-bag	MOQ
21.30.001.00	56	49,5	25	6	77	78	-	100	1000
21.30.003.00	56	49,5	30	6	77	78	-	100	1000

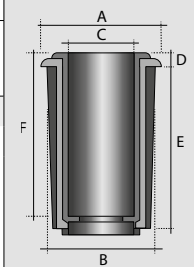



Riduzione per basi cono 50 senza linguetta smontaggio
Reduction for base cone Ø50 without disassembling tongue

RBSL

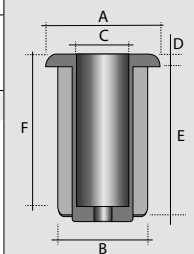
Codice Code	A	B	C	D	E	F	Nero Black		
							€	Pz x conf Pcs box-bag	MOQ
21.30.004.00	56	49,5	25	6	77	78	-	250	1000
21.30.006.00	56	49,5	30	6	77	78	-	250	1000

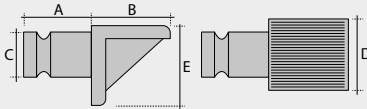

BLR	Blocchetto reggipiani in PP Shelf support in PP											
	Codice Code	A	B	ØC	D	E	Bianco White			Marrone Brown		
							€	Pz x conf Pcs box-bag	MOQ	€	Pz x conf Pcs box-bag	MOQ
	11.27.104.02	11,5	11,5	7	11,5	11,5	-	5000	5000	-	5000	5000
												

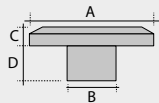
CVIE	Copritesta viti a testa cilindrica in PE (con esagono incassato per vite 6MA) Screw cover in PE (With Hexagon for screw 6MA)										
	Codice Code	ØA	ØB	C	D	Nero Black					
						€	Pz x conf Pcs box-bag	MOQ			
	11.27.125.02	13	5,5	1,5	3,5	-	5000	5000			
											

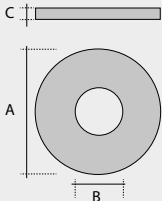
RS	Rondelle sottoviti in HD e PE HD and PE washers										
	Codice Code	Rondelle sottovite washers	ØA	ØB	C	Nero Black			Colorato a richiesta Coloured version on demand		
						€	Pz x conf Pcs box-bag	MOQ	€	Pz x conf Pcs box-bag	MOQ
	11.27.147.02	HD	11	5,5	1,5	-	10000	10000	-	-	-
	11.27.148.02	HD	11,5	3,2	1,2	-	10000	30000	-	-	-
	11.27.149.02	HD	12	4,5	1,5	-	10000	10000	-	-	-
	11.27.150.02	HD	14	6	1,5	-	10000	10000	-	-	-
	11.27.151.02	HD	15	5	1,5	-	10000	10000	-	-	-
	11.27.152.02	HD	16	6	1,5	-	5000	5000	-	-	-
	11.27.153.02	HD	22	10	2,0	-	5000	5000	-	-	-
	11.27.154.02	HD	24	8,5	2,0	-	5000	5000	-	-	-
	11.27.155.02	PE	19	7	2,0	-	5000	5000	-	-	-
											

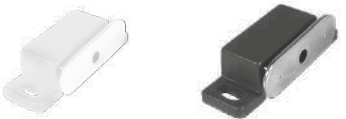
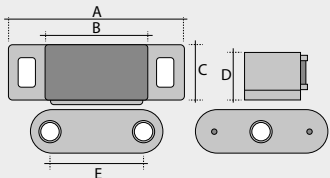
BCM	Blocchetto chiusura magnetica forza trazione Kg.4 Magnetic closure with traction force of 4 Kg												
	Codice Code	N° fori N° holes	A	B	C	D	E	Bianco White			Marrone Brown		
								€	Pz x conf Pcs box-bag	MOQ	€	Pz x conf Pcs box-bag	MOQ
	21.27.174.00	1	47,5	30	16	13	-	-	250	1000	-	250	1000
	21.27.175.00	2	47,5	30	16	13	30	-	100	1000	-	100	1000
													

INDEX

Fermaportine in PS bianco Doorstops in PS white

FP

Codice Code	n° fori n° holes	n° chiodi n° nails	A	B	C	D	E	Bianco White		
								€	Pz x conf Pcs box-bag	MOQ
21.27.168.00	2	-	40	7,5	10,5	24	-	-	500	10000
21.27.169.00	-	2	40	7,5	10,5	24	7	-	500	5000

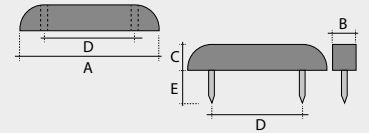

Fermaportine in PS Doorstops in PS

FP

Codice Code	n° fori n° holes	n° chiodi n° nails	A	B	C	D	E	Marrone Brown		
								€	Pz x conf Pcs box-bag	MOQ
21.27.168.00	2	-	40	7,5	10,5	24	-	-	500	10000
21.27.169.00	-	2	40	7,5	10,5	24	7	-	500	5000

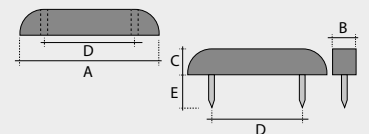

Piedino per gambe legno in PE Glide in PE for wooden legs

P2GL

Codice Code	A	B	C	ØD	E	Nero Black		
						€	Pz x conf Pcs box-bag	MOQ
11.27.120.02	46	20	32	10	4	-	3000	3000

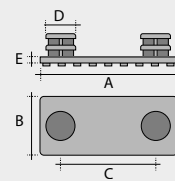

Piedino fisso per mobilett Fixed glide for cabinets

PFM

Codice Code	A	B	C	D	E	F	Nero Black		
							€	Pz x conf Pcs box-bag	MOQ
11.40.570.02	80	47	35	13	12	7	-	250	3000

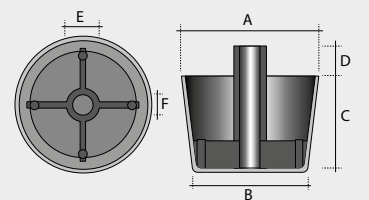
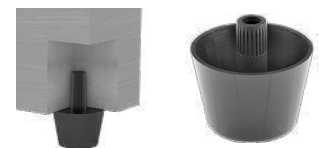

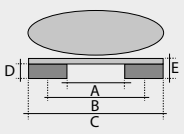

27 | Maniglie per mobili | Handles for furniture

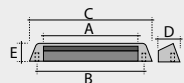
MOB		Maniglia ovale in PS antiurto nera con buccola ottone filet o 4MA Oval handle in PS with brass plated knob thread 4MA									
		Codice Code	ØA	ØB	C	D	E	Nero Black			
								€	Pz x conf Pcs box-bag	MOQ	
		11.28.111.30	67	78	94	10	13	-	500	500	

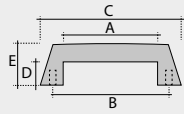
MTT		Maniglia trapezoidale in PA con buccola ottone filet o 4MA Trapezoidal handle in PA with brass plated knob thread 4MA									
		Codice Code	ØA	ØB	C	D	E	Nero Black			
								€	Pz x conf Pcs box-bag	MOQ	
		11.28.145.77	107	120	140	21	25	-	100	100	

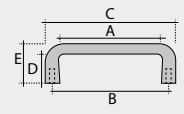
MDA		Maniglia in ABS con buccola ottone filet o 4MA Handle in ABS with brass plated knob thread 4MA																
		Codice Code	A	B	C	D	E	Nero Black										
								€	Pz x conf Pcs box-bag	MOQ								
										21.28.113.00	60	73	90	15	26	-	100	2000
										21.28.114.00	86	100	120	15	26	-	100	2000
		21.28.115.00	116	130	152	15	26	-	100	2000								

MDB		Maniglia in ABS con buccola ottone filet o 4MA Handle in ABS with brass plated knob thread 4MA											
		Codice Code	A	B	C	D	E	Nero Black			Cromato Chrome plated		
								€	Pz x conf Pcs box-bag	MOQ	€	Pz x conf Pcs box-bag	MOQ
										21.28.117.00	80	90	100
		21.28.118.00	97	108	118	26	33	-	100	2000	-	100	2000

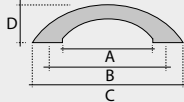
MMC		Maniglia mobili curva in PP Curved handle in PP										
		Codice Code	A	B	C	D	Nero Black			Colorato a richiesta Coloured version on demand		
							€	Pz x conf Pcs box-bag	MOQ	€	Pz x conf Pcs box-bag	MOQ
									11.28.159.02	52	64	87
		11.28.170.02	88	96	123	28	-	1500	1500	-	-	-

Vite da utilizzare autofilettanti: TC UNI 9707 Ø3.5
Self-tapping screws to be used: TC UNI 9707 Ø3.5

Maniglia curva larga in PP
Wide curved handle in PP

MCL

Codice Code	A	B	C	D	E	F	Nero Black			Colorato a richiesta Coloured version on demand		
							€	Pz x conf Pcs box-bag	MOQ	€	Pz x conf Pcs box-bag	MOQ
							11.28.201.02	56	62	92	23	18

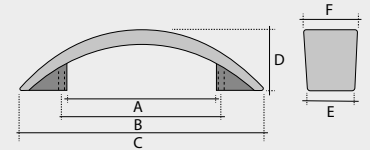

Maniglia curva ellittica in PP
Curved elliptical handle in PP

MCE

Codice Code	A	B	C	D	Nero Black			Colorato a richiesta Coloured version on demand		
					€	Pz x conf Pcs box-bag	MOQ	€	Pz x conf Pcs box-bag	MOQ
					11.28.205.02	81	96	113	27	-

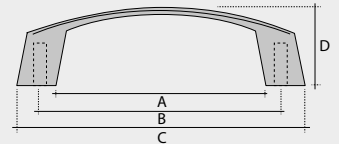

Maniglia a filo in P
Wire handle in PP

MF

Codice Code	A	B	C	Nero Black			Colorato a richiesta Coloured version on demand		
				€	Pz x conf Pcs box-bag	MOQ	€	Pz x conf Pcs box-bag	MOQ
				11.28.166.02	95	10	35	-	1500

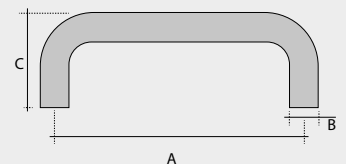

INDEX

RMF

Rondelle per maniglia a filo in P
Washers in PP for wire handle

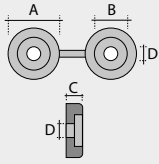

Codice Code	A	B	C	D	Nero Black			Colorato a richiesta Coloured version on demand		
					€	Pz x conf Pcs box-bag	MOQ	€	Pz x conf Pcs box-bag	MOQ
11.28.167.02	15	10	3,5	3,8	-	1500	9000	-	-	-

MML

Maniglietta in PP
Handle in PP

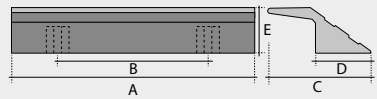
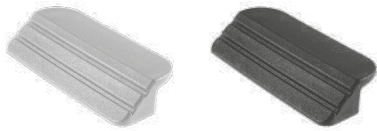

Codice Code	A	B	C	D	E	Nero Black			Colorato a richiesta Coloured version on demand		
						€	Pz x conf Pcs box-bag	MOQ	€	Pz x conf Pcs box-bag	MOQ
11.28.210.02	90	64	48	22	16	-	1000	1000	-	-	-

Maniglia nera in PS antiurto
Shock proof handle in PS

MI

Codice Code	A	B	C	D	Nero Black		
					€	Pz x conf Pcs box-bag	MOQ
11.28.164.03	80x27	100	36	13	-	1000	1000

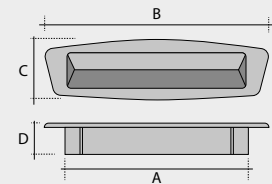

Maniglia a scatto in PS antiurto (Per sportelli scorrevoli in metallo.)
Shockproof snap-on handle in PS

MIS

Codice Code	A	B	C	D	Nero Black			Colorato a richiesta Coloured version on demand		
					€	Pz x conf Pcs box-bag	MOQ	€	Pz x conf Pcs box-bag	MOQ
11.28.165.03	17x120	126	25	13	-	1000	1000	-	-	-

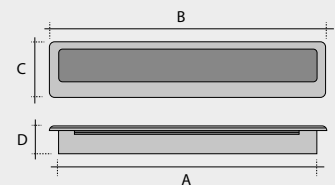

Maniglia rotonda in PS antiurto interno liscio
Round handle, shock proof in PS

MIR

Codice Code	A	B	C	D	Nero Black		
					€	Pz x conf Pcs box-bag	MOQ
11.28.150.03	22	20	28	10	-	1500	6000
11.28.151.03	30	27	36	12	-	1000	1000
11.28.152.03	40	36	50	14	-	1000	1000

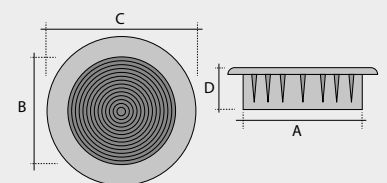

29 | Pomoli vari | Knobs

PBC

Pomello con testa bombata in ABS filettati 4M
Knob with pan head

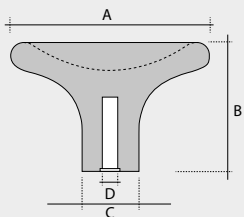

Codice Code	ØA	B	C	D	Nero Black			Cromato Chrome plated		
					€	Pz x conf Pcs box-bag	MOQ	€	Pz x conf Pcs box-bag	MOQ
21.28.179.00	30	17.5	11.5	3.0	-	250	500	-	250	500
21.28.180.00	40	18.0	18.0	4.5	-	100	200	-	100	200
21.28.181.00	50	24.0	24.0	7.0	-	100	100	-	100	100

POMC

Pomello concavo per mobili
Knob with concave head

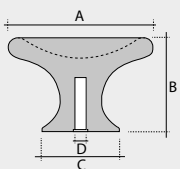

Codice Code	ØA	B	C	D	Nero Black		
					€	Pz x conf Pcs box-bag	MOQ
11.28.220.02	40	25	21	3.2	-	500	500

PFS

Pomoli sferici filettati in AB
Threaded knobs in ABS

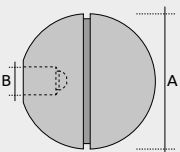

Codice Code	ØA	B	Nero Black		
			€	Pz x conf Pcs box-bag	MOQ
21.28.195.00	20	4MA	-	500	500
21.28.196.00	28	4MA	-	200	200
21.28.197.00	35	4MA	-	100	200

***NEW**

Volantino con gambo filettato in PS antiurto, 6-8 lobi con gambo in FE zincocromato
Star knobs with threaded shank in PS shock proof.

VGF

Codice Code	n° Lobi nr lobes	A	B	C	D	E	F	Nero Black		
								€	Pz x conf Pcs box-bag	MOQ
11.41.350.39*	6	30	10	8	17	M5	13.5	-	500	10000
11.41.159.39	6	30	10	8	12	M6	13.5	-	500	1000
11.41.150.39	6	30	10	8	17	M6	13.5	-	500	1000
11.41.152.39	6	30	10	8	22	M6	13.5	-	500	1000
11.41.151.40	6	30	10	8	20	M8	13.5	-	500	1000
11.41.101.40	8	40	11	7	20	M8	16	-	250	1000
11.41.102.40	8	40	11	7	20	M10	16	-	250	1000
11.41.134.40	8	50	14	8,5	15	M8	18	-	150	10000
11.41.130.40	8	50	14	8,5	20	M10	18	-	150	450
11.41.139.40	8	50	14	8,5	25	M8	18	-	150	10000
11.41.132.40	8	50	14	8,5	25	M10	18	-	150	450
11.41.131.40	8	50	14	8,5	30	M10	18	-	150	450
11.41.220.40	8	60	15	9	20	M10	18	-	100	400
11.41.221.40	8	60	15	9	25	M10	18	-	100	1000
11.41.222.40	8	60	15	9	30	M10	18	-	100	1000

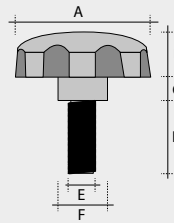

Volantino Jolly basso in PP con gambo in FE zincocromato
Star knob in PP with zinc plated shank

VJB

Codice Code	ØA	B	C	D	E	Nero Black		
						€	Pz x conf Pcs box-bag	MOQ
11.41.248.73	50	24	1,5	10	M8	-	500	500
11.41.246.73	50	24	1,5	15	M8	-	500	500
11.41.249.73	50	24	1,5	20	M8	-	500	500
11.41.250.73	50	24	1,5	25	M8	-	500	500
11.41.251.73	50	24	1,5	30	M8	-	500	500

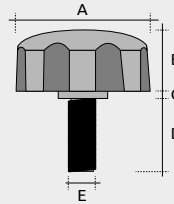

Volantino Jolly basso in PP con battuta in FE e gambo in FE zincocromato
Star knob in PP with zinc plated shank

VJBB

Codice Code	ØA	B	C	D	E	Nero Black		
						€	Pz x conf Pcs box-bag	MOQ
11.41.312.73	50	24	1,5	15	M8	-	500	5000

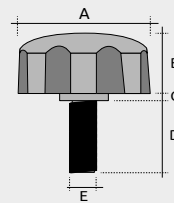

Volantino Jolly alto in PP con gambo in FE zincocromato
Star knob in PP with zinc plated shank

VJA

Codice Code	ØA	B	C	D	E	Nero Black		
						€	Pz x conf Pcs box-bag	MOQ
11.41.247.73	50	24	11,5	15	M8	-	500	500
11.41.241.73	50	24	11,5	25	M8	-	500	500

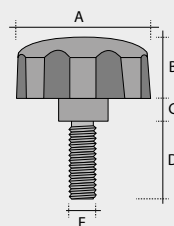

INDEX

VJAB

Volantino jolly alto in PP con battuta in FE e gambo in FE zincocromato
Star knob in PP with zinc plated shank

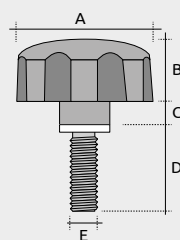

Codice Code	ØA	B	C	D	E	Nero Black		
						€	Pz x conf Pcs box-bag	MOQ
11.41.310.73	50	24	11,5	15	M8	-	500	500
11.41.311.73	50	24	11,5	25	M8	-	500	5000

VJS

Volantino Jolly in PP con gambo in FE zincocromato
Star knob in PP with threaded zinc-plated shank

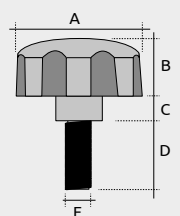

Codice Code	ØA	B	C	D	E	Nero Black		
						€	Pz x conf Pcs box-bag	MOQ
11.41.255.73	50	24	11,5	30	M8	-	500	500

VJSB

Volantino Jolly in PP con battuta in FE
Star knob in PP with zinc plated shank

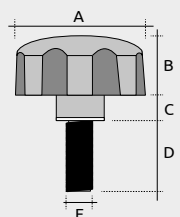

Codice Code	ØA	B	C	D	E	Nero Black		
						€	Pz x conf Pcs box-bag	MOQ
11.41.313.73	50	24	11,5	30	M8	-	500	500

VSE

Volantini sottoplastra economici in PP con gambo in FE zincocromato
Star knob in PP with zinc plated shank

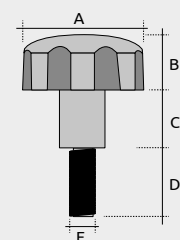

Codice Code	ØA	B	C	D	E	Nero Black		
						€	Pz x conf Pcs box-bag	MOQ
11.41.260.73	50	24	25,5	30	M8	-	500	500

Volantini sottoplastra in PP con battuta in FE e gambo in FE zincocromato
Star knob in PP with zinc plated shank

VSEB

Codice Code	ØA	B	C	D	E	Nero Black		
						€	Pz x conf Pcs box-bag	MOQ
11.41.262.73	50	24	30	30	M8	-	250	250

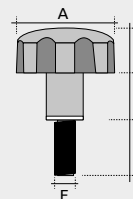

Volantino jolly in PP-gambo e battuta in FE zincocromato
Star knob in PP with zinc plated shank

VGJ

Codice Code	ØA	B	C	D	E	Nero Black		
						€	Pz x conf Pcs box-bag	MOQ
11.41.245.73	50	54	30	23	M8	-	250	250

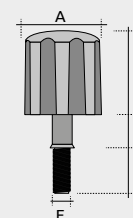

Volantino Twist in PP con gambo e battuta in FE zincocromato
Star knob in PP with zinc plated shank

VTB

Codice Code	ØA	B	C	D	E	Nero Black		
						€	Pz x conf Pcs box-bag	MOQ
11.41.320.73	55	25	25	9	M8	-	500	500

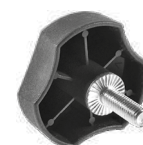
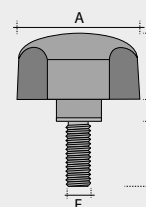

Volantino a 3 punte ovale in PP con gambo in FE zincocromato
Star knob in PP with zinc plated bolt

V30

Codice Code	ØA	B	C	D	E	Nero Black		
						€	Pz x conf Pcs box-bag	MOQ
11.41.289.73	63	22	18	15	M8	-	250	1000
11.41.290.73	63	22	12	30	M8	-	250	1000
11.41.292.73	63	22	18	32	M6	-	250	1000

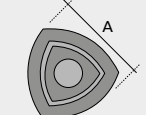
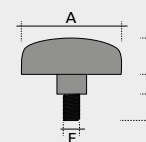

INDEX

VZF

Volantini sottoplastra economici in PP con gambo in FE zincocromato
Star knob in PP with zinc plated shank

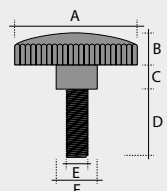

Codice Code	ØA	B	C	D	E	F	Nero Black		
							€	Pz x conf Pcs box-bag	MOQ
11.41.180.37	50	16	8	20	M10	18	-	450	450
11.41.181.37	50	16	8	25	M10	18	-	450	900
11.41.182.37	50	16	8	30	M10	18	-	450	450

VPHA

Volantino - Piede regol in PE nero con base esagonale e gambo in FE zincocromato
Adjustable knob|glide in PE with hexagonal base and zinc-plated shank

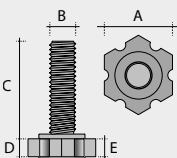

Codice Code	ØA	B	C	D	E	Nero Black		
						€	Pz x conf Pcs box-bag	MOQ
11.40.538.64	22	M8	20	11	6	-	1000	1000

VPR

Volantino - Piedino regolabile
knob| adjustable glide

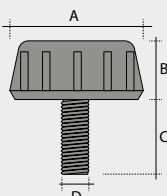

Codice Code	ØA	B	C	D	Nero Black		
					€	Pz x conf Pcs box-bag	MOQ
11.41.330.73	30	13	20	M8	-	1000	1000
11.41.331.73	40	15	20	M8	-	500	3000
11.41.332.73	40	15	30	M10	-	500	1000
11.41.333.73	50	17	20	M8	-	500	1000
11.41.334.73	50	17	30	M10	-	500	1000

VGE

Volantino EVE con gambo M8x14
Star knob EVE M8X14

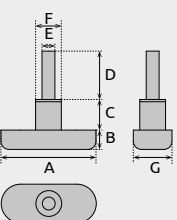

Codice Code	A	B	C	D	E	F	G	Nero Black		
								€	Pz x conf Pcs box-bag	MOQ
11.41.340.73N	59	12	18	15	M8	Ø18	24	-	500	2500

Volantino cieco in PS antiurto con bussola in metallo filettata serie a 6-8 lobi
6-8 lobe star blind knob in PS with metal threaded bush

VCF

Codice Code	n° Lobi nr lobes	A	B	C	D	E	F	Nero Black		
								€	Pz x conf Pcs box-bag	MOQ
11.41.160.30	6	30	10	8	M6	13,5	14	-	500	1000
11.41.161.30	6	30	10	8	M8	13,5	14	-	500	1000
11.41.104.30	8	40	12	6,5	M6	16	14	-	250	1250
11.41.105.30	8	40	12	6,5	M8	16	14	-	250	1250
11.41.109.30	8	40	12	15	M8	16	20	-	250	1000
11.41.140.30	8	50	14	9,5	M8	18	18	-	150	450
11.41.142.30	8	50	14	9,5	M10	18	16	-	150	450
11.41.210.30	8	60	15	9	M10	18	18	-	150	900
11.41.211.30	8	60	15	9	M8	18	18	-	150	900

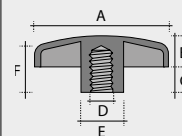

Volantino Jolly basso in PP con bussola in metallo filettata
Star knob in PP with metal threaded bush

VJF

Codice Code	ØA	B	C	E x F	Nero Black		
					€	Pz x conf Pcs box-bag	MOQ
11.41.229.94	50	24	11,5	M6 x 25	-	500	500
11.41.230.94	50	24	11,5	M8 x 16	-	500	500
11.41.231.94	50	24	11,5	M10 x 16	-	500	500

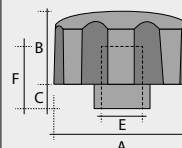

Volantino in PA con bussola in metallo filettata serie rotondo zigrinato
Star knob in PA with metal threaded bush

VZC

Codice Code	ØA	B	C	D	E	F	Nero Black		
							€	Pz x conf Pcs box-bag	MOQ
11.41.190.77	50	14	9,5	M8	18	18	-	450	900
11.41.191.77	50	14	9,5	M10	18	16	-	450	900

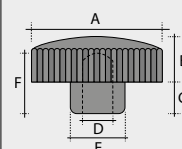

INDEX

VFP

Volantino con foro passante in PS con buccola metallo serie 8 lobi
Star knob in PS with metal threaded bush

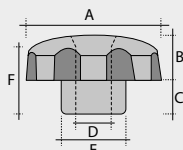
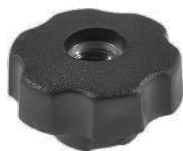

Codice Code	A	B	C	D	E	F	Nero Black		
							€	Pz x conf Pcs box-bag	MOQ
11.41.269.30	30	10	8	M8	13,5	14	-	500	500

VCE

Volantino EVE cieco M8x14
Blind knob M8x14

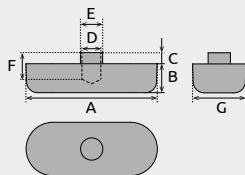

Codice Code	A	B	C	D	E	F	G	Nero Black		
								€	Pz x conf Pcs box-bag	MOQ
11.41.342.94N	59	16	4	M8	15	12	24	-	500	2500
11.41.341.94N	75	16	6	M8	15	15	24	-	500	1000

Dadi con alette in PS antiurto con gambo FE zincocromato
Wing screws in PS with zinc-plated bolt

DGA

Codice Code	A	B	C	D	E	Nero Black			Colorato a richiesta Coloured version on demand		
						€	Pz x conf Pcs box-bag	MOQ	€	Pz x conf Pcs box-bag	MOQ
11.41.113.39	44	25	11	M6	20	-	500	5000	-	-	-
11.41.110.39	44	25	15	M6	20	-	500	500	-	-	-
11.41.111.40	44	25	20	M8	20	-	500	500	-	-	-

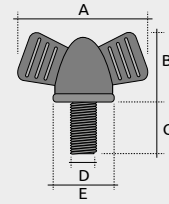

Dadi con alette in PS antiurto
Wing screws in PS

DCA

Codice Code	ØA	B	C	D	E	Nero Black			Colorato a richiesta Coloured version on demand		
						€	Pz x conf Pcs box-bag	MOQ	€	Pz x conf Pcs box-bag	MOQ
11.41.114.30	44	25	M6	20	11	-	500	500	-	-	-
11.41.115.30	44	25	M6	20	14	-	500	500	-	-	-

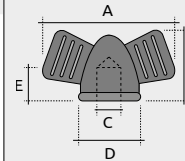

B4G

Bussole filettate in FE
Iron T-nut

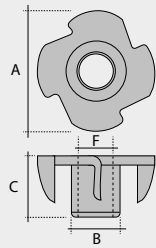

Codice Code	Filetto Thread	A	ØB	C	Fe Iron		
					€	Pz x conf Pcs box-bag	MOQ
11.40.210.67	5 x 0.80	17	6.2	8	-	10000	10000
11.40.211.67	6 x 1.00	19	8.0	10	-	7000	7000
11.40.212.67	8 x 1.25	22	9.5	11	-	4500	4500
21.40.213.00	10 x 1.50	25	12.0	11	-	3000	3000
11.40.215.67	1¼ W	19	8.0	10	-	7000	7000

BAR

Buccola autofilettante a ragno in PA (Adatte per assemblaggio scocche)
Spider T-nut in PA (Suitable for shells' assembly)

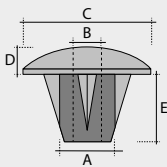

Codice Code	ØA	ØB	ØC	D	E	Nero Black		
						€	Pz x conf Pcs box-bag	MOQ
11.40.201.05	8	4	19	3	10	-	5000	10000

Regolabili in FE con base in plastica - gambo e ghiera in FE zincocromati - filet o MA
Adjustable foot with plastic base and zinc-plated screw

PRA

Codice Code	ØA	B	C	D	Cromato Chrome plated		
					€	Pz x conf Pcs box-bag	MOQ
11.40.101.62	20	M6	13	7	-	1000	2000

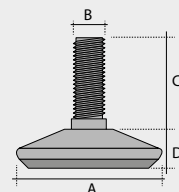

Regolabili in FE-base in plastica - gambo-ghiera in FE zincocromati con filet o
Adjustable foot with plastic base and zinc-plated screw

PRB

Codice Code	ØA	B	C	D	Cromato Chrome plated		
					€	Pz x conf Pcs box-bag	MOQ
11.40.102.62	25	M8	20	10,0	-	250	1000
11.40.103.62	30	M8	20	11,5	-	250	1000
11.40.104.62	35	M8	20	12,0	-	250	1000
11.40.105.62	40	M8	25	13,5	-	250	1000

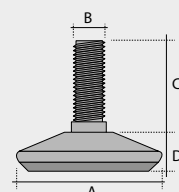

Regolabili in FE-base in plastica - gambo e ghiera in FE zincocromati con filet o
Adjustable foot with plastic base and zinc-plated iron screw

PRC

Codice Code	ØA	B	C	D	Cromato Chrome plated		
					€	Pz x conf Pcs box-bag	MOQ
11.40.110.62	25	M10	20	10,0	-	250	1000
11.40.111.62	30	M10	20	11,5	-	250	1000
11.40.112.62	35	M10	20	12,0	-	250	1000
11.40.113.62	40	M10	25	13,5	-	250	1000
11.40.114.62	50	M10	30	15,5	-	200	600

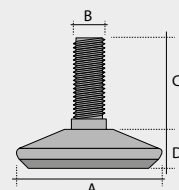

Regolabili in FE-base in plastica - gambo e ghiera in FE zincocromati con filet o
Adjustable foot with plastic base and zinc-plated iron screw

PRD

Codice Code	ØA	B	C	D	Cromato Chrome plated		
					€	Pz x conf Pcs box-bag	MOQ
11.40.120.62	50	M12	35	15,5	-	100	300

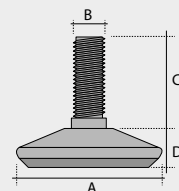

INDEX

RFR

Regolabili in FE con base ricoperta in PE
Iron adjustable foot with base covered in PE

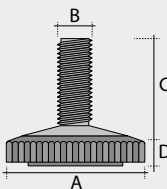

Codice Code	ØA	B	C	D	Nero Black		
					€	Pz x conf Pcs box-bag	MOQ
11.40.350.64	20	M6	20	6,5	-	2000	2000
11.40.351.64	28	M8	22	8	-	500	500
11.40.352.64	32	M10	25	9,5	-	500	500

PREG

Piede regolabile in PP per vite in FE testa esagonale UNI 5739
Iron adjustable foot for screws with hexagonal head UNI 5739

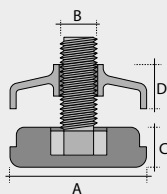

Codice Code	ØA	B	C	D	Nero Black		
					€	Pz x conf Pcs box-bag	MOQ
11.40.232.97	40	10	6	13	-	500	500

PBRB

Regolabili in FE- base in plastica, gambo e ghiera in FE zincocromo filet o MA
Adjustable foot with plastic base and zinc-plated iron screw

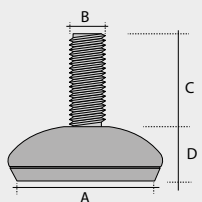

Codice Code	ØA	B	C	D	Nero Black			Cromato Chrome plated		
					€	Pz x conf Pcs box-bag	MOQ	€	Pz x conf Pcs box-bag	MOQ
11.40.582.63	30	M8	20	-	-	500	500	/	/	/
11.40.582.62	30	M8	20	-	/	/	/	-	500	500
11.40.584.63	40	M8	20	12	-	250	250	/	/	/
11.40.584.62	40	M8	20	12	/	/	/	-	250	250

PBRC

Regolabili in FE-base in plastica -gambo e ghiera in FE zincocrom filet o MA
Adjustable foot with plastic base and zinc-plated iron screw

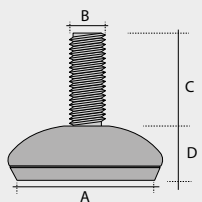
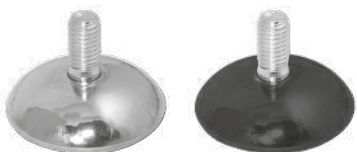

Codice Code	ØA	B	C	D	Nero Black			Cromato Chrome plated		
					€	Pz x conf Pcs box-bag	MOQ	€	Pz x conf Pcs box-bag	MOQ
11.40.592.63	30	M10	20	-	-	500	2500	/	/	/
11.40.592.62	30	M10	20	-	/	/	/	-	500	2500
11.40.594.63	40	M10	20	12	-	250	2500	/	/	/
11.40.594.62	40	M10	20	12	/	/	/	-	250	2500
11.40.595.63	50	M10	20	13	-	100	1000	/	/	/
11.40.595.62	50	M10	20	13	/	/	/	-	100	100

Regolabili in FE-base in plastica, gambo e ghiera in FE zincocrom filet o MA
Adjustable foot with plastic base and zinc-plated iron screw

PBRD

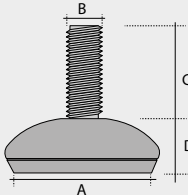
Codice Code	A	B	C	D	Nero Black			Cromato Chrome plated			
					€	Pz x conf Pcs box-bag	MOQ	€	Pz x conf Pcs box-bag	MOQ	
-	50	M12	-	-	-	-	-	-	-	-	

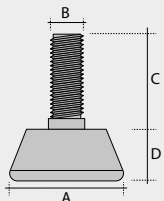

Regolabili con base in PE nero e gambo in FE zincocromato
Adjustable foot with black PE base and zinc-plated iron screw

PRP

Codice Code	ØA	B	C	D	Nero Black			
					€	Pz x conf Pcs box-bag	MOQ	
11.40.150.63	30	M8	20	11.5	-	1000	1000	
11.40.151.63	40	M8	25	14.5	-	500	500	
11.40.152.63	30	M10	20	11.5	-	1000	1000	
11.40.153.63	40	M10	25	14.5	-	500	500	
11.40.154.64	50	M10	35	17.0	-	250	250	
11.40.155.64	50	M12	35	17.0	-	250	250	
11.40.310.64	60	M12	37	17.0	-	250	250	
11.40.311.64	60	M10	37	17.0	-	250	250	

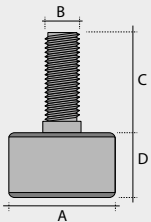

Regolabili cilindrici con base in PE nero e gambo in FE zincocromato
Adjustable cylindrical foot with black PE base and zinc-plated iron screw

PCR

Codice Code	ØA	B	C	D	Nero Black				
					€	Pz x conf Pcs box-bag	MOQ		
11.40.160.63	23	M8	20	12	-	1000	1000		
11.40.161.63	23	M10	20	12	-	1000	1000		

Piedi regol base alta in PA nero con impronta per chiave esagonale per avvitarmento
Adjustable foot with black PA base, for hexagonal screwing

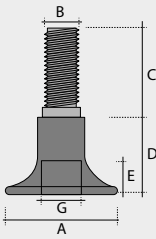
RBA

Codice Code	ØA	B	C	D	E	F	G	Nero Black				
								€	Pz x conf Pcs box-bag	MOQ		
11.40.240.37	35	M10	25	24	11	14	10	-	5000	5000		

INDEX

PRS

Piede regolabile stampato in PA
Adjustable foot in PA

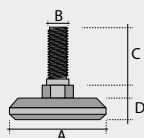

Codice Code	ØA	B	C	D	E	Nero Black		
						€	Pz x conf Pcs box-bag	MOQ
11.40.165.05	30	M10	20	5	10	-	1000	1000

RPN

Piede regolabile piatto
Adjustable flat foot

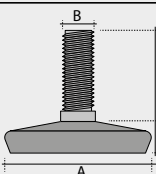

Codice Code	ØA	B	C	D	Nero Black		
					€	Pz x conf Pcs box-bag	MOQ
11.40.297.37	40	M8	20	10	-	500	500
11.40.298.37	40	M10	20	10	-	500	500

PGS

Piedino per gambe scrivania
Flat foot for desk

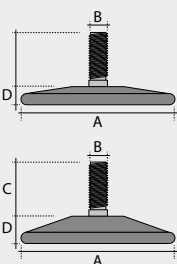

Codice Code	A	B	C	D	Nero Black		
					€	Pz x conf Pcs box-bag	MOQ
11.40.400.63	60	M8	35	7	-	500	500
11.40.401.63	60	M10	35	7	-	500	1000
11.40.221.63	80	M8	20	14	-	250	250
11.40.220.63	80	M10	20	14	-	250	250
11.40.380.63	100	M8	20	18	-	250	500
11.40.383.63	100	M8	25	18	-	250	250
11.40.381.63	100	M10	20	18	-	250	250
11.40.384.63	100	M10	25	18	-	125	500

PASA

Piedino regolabile
Adjustable foot

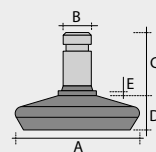

Codice Code	ØA	ØB	C	D	E	Nero Black		
						€	Pz x conf Pcs box-bag	MOQ
11.40.301.26	40	11	20	10	3,5	-	500	500
11.40.302.26	40	10	20	10	3,5	-	500	500

RPMG

Regolabile in PE con pattino e ghiera in FE gambo cromato
Adjustable foot in PE with metal-covered plastic base

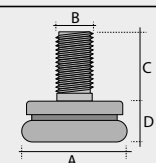

Codice Code	ØA	ØB	C	D	Cromato Chrome plated		
					€	Pz x conf Pcs box-bag	MOQ
11.40.461.62	30	M8	25	16	-	500	1000
11.40.462.62	30	M10	25	16	-	500	1000

Regolabili con pattini in acciaio (Base in PA e gambo in FE zincocromato)
Adjustable foot with steel skid (Base in PA and zinc-plated bolt)

RPM

Codice Code	ØA	B	C	D	Nero Black		
					€	Pz x conf Pcs box-bag	MOQ
11.40.171.62	30	M8	25	12.5	-	500	500
11.40.172.62	30	M10	25	12.5	-	500	500
11.40.174.62	40	M8	25	13.0	-	500	500
11.40.173.62	40	M10	25	13.0	-	500	500

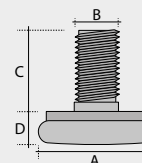

Piede regol. vite girevole a testa esag. mm.17- gambo FE zincocrom (Base in PA nera e gambo in FE zincocromato)
Adjustable foot (base in PA and zinc-plated iron bolt)

PRG

Codice Code	ØA	B	C	D	E	Nero Black			Cromato Chrome plated		
						€	Pz x conf Pcs box-bag	MOQ	€	Pz x conf Pcs box-bag	MOQ
11.40.399.34	28	M10	30	-	6,5	-	-	10000	/	/	/
11.40.399.35	28	M10	30	-	6,5	/	/	/	-	-	10000
11.40.234.34	40	M10	40	11,5	6,5	-	500	500	/	/	/
11.40.234.35	40	M10	40	11,5	6,5	-	-	-	/	500	500
11.40.235.34	40	M10	60	11,5	6,5	-	400	400	/	/	/
11.40.235.35	40	M10	60	11,5	6,5	/	/	/	-	400	400
11.40.236.34	50	M10	40	13,5	6,5	-	300	300	/	/	/
11.40.236.35	50	M10	40	13,5	6,5	/	/	/	-	300	300
11.40.237.34	50	M10	60	13,5	6,5	-	250	250	/	/	/
11.40.237.35	50	M10	60	13,5	6,5	/	/	/	-	250	250

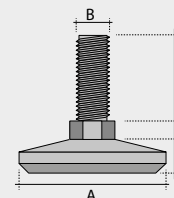

Piede regolabile con esagono e vite girevole (Base in PA nera o con ghiera cromata e gambo zincocromato)
Adjustable screw (base in PA or chromed base and zinc-plated iron bolt)

PGT

Codice Code	ØA	B	C	D	E	Nero Black			Cromato Chrome plated		
						€	Pz x conf Pcs box-bag	MOQ	€	Pz x conf Pcs box-bag	MOQ
11.40.290.27	40	M10	25	11,5	6	-	500	500	/	/	/
11.40.290.28	40	M10	25	11,5	6	/	/	/	-	500	500
11.40.291.27	50	M10	30	13,0	6	-	300	300	/	/	/
11.40.291.28	50	M10	30	13,0	6	/	/	/	-	300	600
11.40.292.37	50	M12	35	13,0	6	-	250	1000	/	/	/
11.40.292.38	50	M12	35	13,0	6	/	/	/	-	250	1000

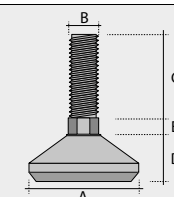
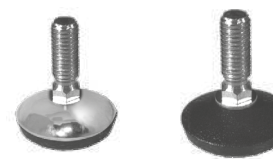

Piede regolabile con vite girevole a testa esagonale mm.17 (Base e vite in FE zincocromato)
Adjust foot with revolving screw and hexagonal head mm.17 (Base and screw in zinc-plated iron)

PRGB

Codice Code	ØA	B	C	D	E	Fe Zinc-plated		
						€	Pz x conf Pcs box-bag	MOQ
11.40.182.36	46	M10	40	7	6,5	-	400	400
11.40.184.36	46	M10	60	7	6,5	-	350	350

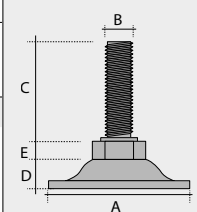

A richiesta si può variare filetto e lunghezza gambi.
It is possible to change the thread and the length of bolts

INDEX

PRGC

Piede regolabile con vite girevole a testa esagonale mm.17 (Base e vite FE zincocromate)
Adjustable foot with revolving screw and hexagonal head mm.17- (Base and screw in zinc-plated)

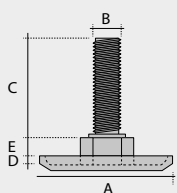

Codice Code	ØA	B	C	D	E	Fe Zinc-plated		
						€	Pz x conf Pcs box-bag	MOQ
11.40.420.36	50	M10	40	3	6,5	-	200	200
11.40.422.36	50	M10	60	3	6,5	-	200	1000

A richiesta si può variare filetto e lunghezza gambi.
It is possible to change the thread and the length of bolts

VPHA

Piede regolabile in PE nero con base esagonale e gambo in FE zincocromato
Adjustable black foot in PE with hexagonal base and zinc-plated iron bolt

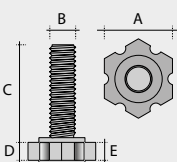

Codice Code	A	B	C	D	E	Nero Black		
						€	Pz x conf Pcs box-bag	MOQ
11.40.535.64	17	M6	14	10	5	-	1000	1000
11.40.538.64	22	M8	20	11	6	-	1000	1000

VPR

Volantino/Piedino regolabile
Knob/adjustable foot

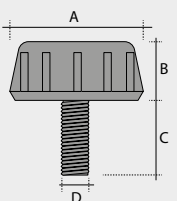

Codice Code	A	B	C	D	Nero Black		
					€	Pz x conf Pcs box-bag	MOQ
11.41.330.73	30	13	20	M8	-	1000	1000
11.41.331.73	40	15	20	M8	-	500	3000
11.41.332.73	40	15	30	M10	-	500	1000
11.41.333.73	50	17	20	M8	-	500	1000
11.41.334.73	50	17	30	M10	-	500	1000

PBZ

Piede regolabile in PE nero con base zigrinata - gambo in FE zincocromato
Adjustable foot in PE with zinc-plated iron bolt

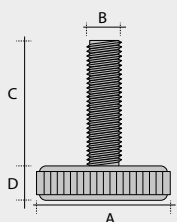

Codice Code	ØA	B	C	D	Nero Black		
					€	Pz x conf Pcs box-bag	MOQ
11.40.450.64	20	M6	17	5,5	-	2000	2000
11.40.479.64	25	M6	17	7	-	1000	1000
11.40.480.64	25	M8	25	7	-	1000	1000
11.40.485.64	25	M10	35	7	-	500	500
11.40.451.64	28	M8	25	6,5	-	500	500
11.40.452.64	28	M10	35	6,5	-	500	1000
11.40.453.64	32	M8	25	7	-	500	1000
11.40.454.64	32	M10	35	7	-	500	1000
11.40.500.64	35	M8	25	9	-	500	500
11.40.506.64	35	M10	25	9	-	500	500
11.40.507.64	35	M10	30	9	-	500	500
11.40.505.64	35	M10	35	9	-	500	500
11.40.508.64	35	M10	40	9	-	500	500
11.40.490.64	40	M10	35	9	-	500	500
11.40.515.64	50	M10	35	9,5	-	500	500
11.40.475.64	60	M10	35	10,5	-	500	500

Piede regolabile in PE nero con base esagonale e gambo in FE zincocromato
Adjustable foot in PE with hexagonal base and zinc-plated iron bolt

VPH

Codice Code	A	B	C	D	Nero Black		
					€	Pz x conf Pcs box-bag	MOQ
11.40.520.64	25	M8	25	8	-	1000	1000
11.40.523.64	25	M10	25	8	-	500	1000
11.40.526.64	25	M8	35	8	-	1000	1000
11.40.529.64	25	M10	35	8	-	500	1000

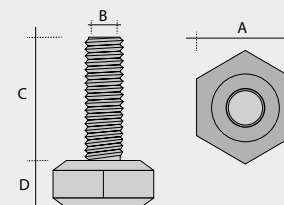

Piede regol-base grande e esagono mm 20 in PA con gambo in FE zincocromato
Adjustable foot in PA with large base and hexagonal mm.20 - zinc-plated iron bolt

PRBG

Codice Code	A	B	C	D	Nero Black		
					€	Pz x conf Pcs box-bag	MOQ
11.40.232.37	38	M8	25	15	-	500	500

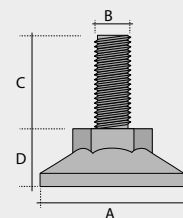

Piede regol con base piccola e esagono mm 20 in PA - gambo in FE zincocromato
Adjustable foot in PA with small base and hexagon mm.20 and zinc-plated iron bolt

PREP

Codice Code	A	B	C	D	Nero Black		
					€	Pz x conf Pcs box-bag	MOQ
11.40.233.37	24	M8	23	14	-	500	500

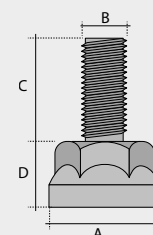

Piedino per meccanismo letto
Adjustable foot for bed mechanism

PPML

Codice Code	A	B	C	D	Nero Black		
					€	Pz x conf Pcs box-bag	MOQ
11.40.615.73	Ø25	M10	30	80	-	250	250

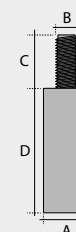

INDEX

PMU

Piedino per mobili regolabile con base snodata (Piedino,dado e base snodata montati)
Adjustable tilt glide for furniture-Adjustable foot,bolt and base are supplied assembled

Codice Code	A	B	C	D	E	Nero Black		
						€	Pz x conf Pcs box-bag	MOQ
11.40.562.73	12	28	Ø50	Ø10	Chiave 4	-	400	400

PMU4

Piedino per mobili regolabile con base snodata (Piedino,dado e base snodata montati)
Adjustable tilt glide for furniture-Adjustable foot,bolt and base are supplied assembled

Codice Code	A	B	C	D	E	Nero Black		
						€	Pz x conf Pcs box-bag	MOQ
11.40.560.99	12	28	Ø50	Ø10	Chiave 4	-	125	1000

PMUC

Piedino per mobili regol con base snodata- Piedino, dado, base snodata montati.
Adjustable tilt glide for furniture - Adjustable foot, bolt and base supplied assembled

Codice Code	A	B	C	D	E	Nero Black			Grigio Grey		
						€	Pz x conf Pcs box-bag	MOQ	€	Pz x conf Pcs box-bag	MOQ
21.40.563.00	12	17	Ø50	Ø10	Chiave 4-key 4	-	1000	1000	-	1000	5000
21.40.562.00	12	27	Ø50	Ø10	Chiave 4-key 4	-	500	1000	-	500	5000
21.40.564.00	-	44	Ø50	Ø10	Chiave 4-key 4	-	400	800	-	400	4000

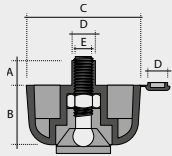

IVC

Piedino regolabile quadro
Adjustable square foot

Base ottagonale / Octagonal base					Nero Black			
Codice Code	Materiale Material	A	B	C	D	€	Pz x conf Pcs box-bag	MOQ
11.40.540.05	PA6	30x30	OCT 27	28	6	-	1500	1500
11.40.540.02	PP	30x30	OCT 27	28	6	-	1500	1500

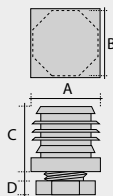

Base esagonale / Hexagonal base					Nero Black			
Codice Code	Materiale Material	A	B	C	D	€	Pz x conf Pcs box-bag	MOQ
11.40.544.02	PP	40x40	HEX 27.5	34	4,8	-	500	500

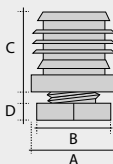

Base rotonda con esagono / Hexagonal round base					Nero Black				
Codice Code	Materiale Material	A	B	C	D	E	€	Pz x conf Pcs box-bag	MOQ
11.40.541.02	PP	30x30	HEX 21	28	12	Ø30	-	1500	1500

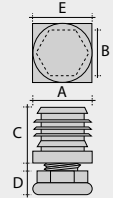

Piede regolabile con base esagonale
Adjustable foot with hexagonal base

IVR

Codice Code	A	B	C	D	E	Nero Black		
						€	Pz x conf Pcs box-bag	MOQ
11.40.545.02	40	34	5	31	16	-	1000	1000

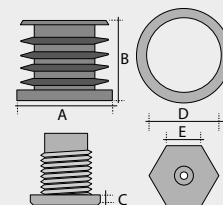

Piede regolabile per gambe scrivania per tubo Ø60 sp.1 mm
Adjustable foot for desk for tube Ø60 thickness 1 mm

PGSR

Codice Code	A	ST	B	C	D	E	F	Nero Black		
								€	Pz x conf Pcs box-bag	MOQ
11.40.390.02	64	1	12	30	8	38	58	-	200	200

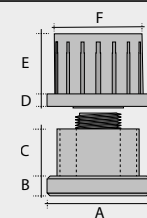

Piede per base armadio in PPN
PPN cabinet foot for wardrobe

-

Codice Code	A	B	C	D	E	Nero Black		
						€	Pz x conf Pcs box-bag	MOQ
19.12.324.94	58	95	M8	28	Ø11	-	100	1000

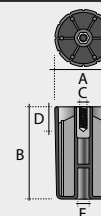

Piedino per fissaggio panc
Foot for bench fixin

PFFPA

Codice Code	A	B	C	D	E	Nero Black		
						€	Pz x conf Pcs box-bag	MOQ
11.30.613.99	60	31,5	M10	13	8,5	-	100	100

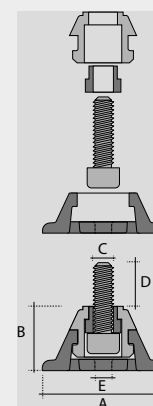

FORO PER
FISSAGGIO AL
PAVIMENTO
FLOOR FIXING
HOLE

35 | Piedini snodati orientabili | Adjustable tilt glides

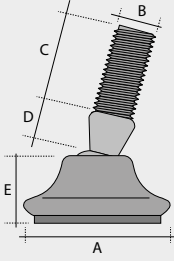
	PS		Con base piana rigata in PE -ghiera in FE cromato e gambo in FE zinco cromato Adjustable tilt glide in PE and chromed zinc plated iron screw						
	Codice Code	A	B	C	D	E	Cromato Chrome plated		
							€	Pz x conf Pcs box-bag	MOQ
	11.40.135.62	25	M8	10	6	11	-	250	1000
	PSC		Con base piana rigata With plane striped base						
	Codice Code	A	B	C	D	E	Cromato Chrome plated		
							€	Pz x conf Pcs box-bag	MOQ
	11.40.138.62	30	M8	10	6	13	-	250	500
	PSD		Con base piana rigata With plane striped base						
	Codice Code	A	B	C	D	E	Cromato Chrome plated		
							€	Pz x conf Pcs box-bag	MOQ
	11.40.140.62	30	M10	12	6	13	-	250	500

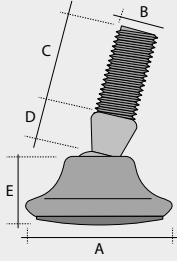

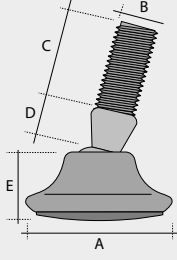
PSA		Con base bombata liscia in PE Chromed foot with plastic base in PE								
		Codice Code	ØA	B	C	D	E	Cromato Chrome plated		
									€	Pz x conf Pcs box-bag
		11.40.136.62	25	M8	10	6	12	-	250	1000

PSB		Con base bombata ricoperta in FE cromato Chromed foot with smooth base								
		Codice Code	ØA	B	C	D	E	Cromato Chrome plated		
									€	Pz x conf Pcs box-bag
		11.40.137.62	25	M8	10	6	13	-	250	1000

INDEX

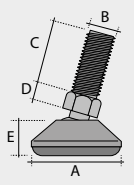

Piedi snodati con esagono 10
Tilt glide with hexagon 10 mm

PSE

Codice Code	ØA	B	C	D	E	Cromato Chrome plated				
						€	Pz x conf Pcs box-bag	MOQ		
11.40.246.62	35	M10	10	5	12	-	250	1000		
11.40.247.62	35	M10	20	5	12	-	250	1000		
11.40.248.62	35	M10	30	5	12	-	250	500		

Piedi snodati con esagono 10
Tilt glide with hexagon 10 mm

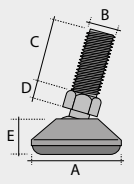
PSG

Codice Code	ØA	B	C	D	E	Cromato Chrome plated				
						€	Pz x conf Pcs box-bag	MOQ		
11.40.206.62	50	M10	10	5	16	-	400	400		
11.40.207.62	50	M10	20	5	16	-	350	350		
11.40.208.62	50	M10	30	5	16	-	350	350		



Con base piana in PP nero e gambo in FE zincocrom
With plane black base in PP and zinc-plated iron bolt

PSF

Codice Code	ØA	B	C	D	E	Nero Black				
						€	Pz x conf Pcs box-bag	MOQ		
11.40.128.37	26	M8	10	6	11,5	-	1000	1000		

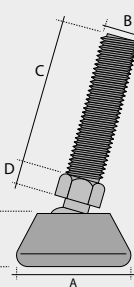

Base in PP nero gambo con esagono 10 mm
Black base in PP with hexagon 10 mm

PSH

Codice Code	ØA	B	C	D	E	Nero Black				
						€	Pz x conf Pcs box-bag	MOQ		
11.40.129.37	26	M10	10	5	11,5	-	500	1000		
11.40.130.37	26	M10	20	5	11,5	-	500	500		
11.40.131.37	26	M10	30	5	11,5	-	500	500		

Piedi snodati e base in PE piana rigata rivestita in FE cromato
Tilt glide and chrome plated plane-striped base in PE

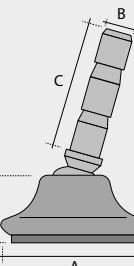
PSE4

Codice Code	A	B	C	D	Cromato Chrome plated				
					€	Pz x conf Pcs box-bag	MOQ		
11.40.337.62	Ø25	Ø6,5	30	11	-	250	1000		

INDEX

PSE5

Con base bombata rivestita in FE cromato
Tilt glide with chromed flat base in Fe

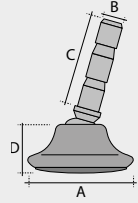

Codice Code	ØA	B	C	D	Cromato Chrome plated		
					€	Pz x conf Pcs box-bag	MOQ
11.40.339.62	25	6,5	30	13	-	250	1000

PSE8

Con base bombata rivestita in FE cromato
Tilt glide with chromed flat base in Fe

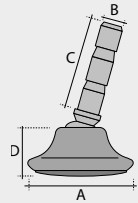

Codice Code	ØA	B	C	D	Cromato Chrome plated		
					€	Pz x conf Pcs box-bag	MOQ
11.40.338.62	25	6,5	30	12	-	250	1000

PSE9

Piedi snodati con base piana
Tilt glides with flat base

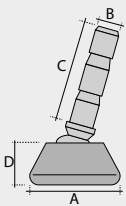

Codice Code	ØA	B	C	D	Nero Black			Neutro Neutral			Cromato Chrome plated		
					€	Pz x conf Pcs box-bag	MOQ	€	Pz x conf Pcs box-ba	MOQ	€	Pz x conf Pcs box-ba	MOQ
11.40.340.37	25	6,5	30	12	-	1000	1000	/	/	/	/	/	/
11.40.342.73	25	6,5	30	12	/	/	/	-	1000	1000	/	/	/
11.40.342.73	25	6,5	30	12	/	/	/	/	/	/	(R)	1000	10000

(R) Richiedere preventivo
Ask for a quotation

PSE9F

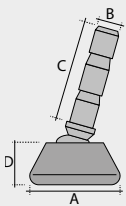

Piedi snodati con base piana in PP neutra pattino in feltro
Tilt glides with plane neutral PP base and felt



Codice Code	ØA	B	C	D	Nero Black			Neutro Neutral		
					€	Pz x conf Pcs box-bag	MOQ	€	Pz x conf Pcs box-bag	MOQ
21.40.344.00	25	6,5	30	12	-	500	1000	-	500	2500

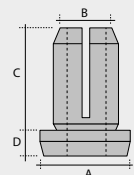

Espansori in PE per PSE 4-5-8-9
Inserts for PSE 4-5-8-9

ES

Codice Code	ØA	B	C	D	Nero Black			Neutro Neutral				
					€	Pz x conf Pcs box-bag	MOQ	€	Pz x conf Pcs box-bag	MOQ		
11.40.334.02	14	10	23	5	-	2000	2000	-	2000	10000		
11.40.335.02	17	13	24	5,5	-	1000	1000	-	1000	10000		
11.40.336.02	18	14	24	5,5	-	1000	1000	-	1000	10000		

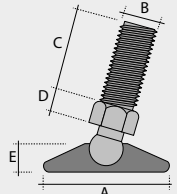

Piedi snodati -base piana in PA nera gambo esagono mm 10 in FE zincocromato
Tilt glide with plane base in PA and zinc-plated iron bolt hexagon 10 mm

PSEP

Codice Code	ØA	B	C	D	E	Nero Black				
						€	Pz x conf Pcs box-bag	MOQ		
11.40.341.37	38	M8	30	4	10	-	500	500		

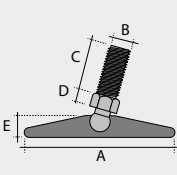

Piedini snodati con base piana in PP
Tilt glide base in PP

PGSI

Codice Code	A	ØB	C	D	E	Nero Black				
						€	Pz x conf Pcs box-bag	MOQ		
11.40.601.73	80	M10	20	4	15	-	250	250		
11.40.602.73	80	M10	30	4	15	-	250	250		
11.40.611.73	100	M10	20	4	21	-	125	1000		
11.40.612.73	100	M10	30	4	21	-	125	250		

Piedi snodati con base e gambo alettato in PP
Tilt glide with base and ribbed stem in PP

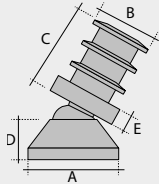
PGSA

Codice Code	Non montato Not assembled	A	ØB	C	D	E	Nero Black				
							€	Pz x conf Pcs box-bag	MOQ		
11.40.315.02	V	25	20x1,5	23,5	11,5	5	-	1000	1000		
11.40.316.02		25	20x1,5	23,5	11,5	5	-	500	3000		

Regol snodato Ø80 per scrivania con gambo esagono CH 17 per tubo Ø50 sp.1,5
Adjust. tilt glide Ø80 for desk with hexagon shank CH17 for tube Ø50 thickness 1,5

PSRS

Codice Code	ØA	B	C	Nero Black			Grigio grey (pantone 429C)			
				€	Pz x conf Pcs box-bag	MOQ	€	Pz x conf Pcs box-bag	MOQ	
11.40.209.92	80	47	38	-	100	500	-	100	2000	

			
---	--	--	--

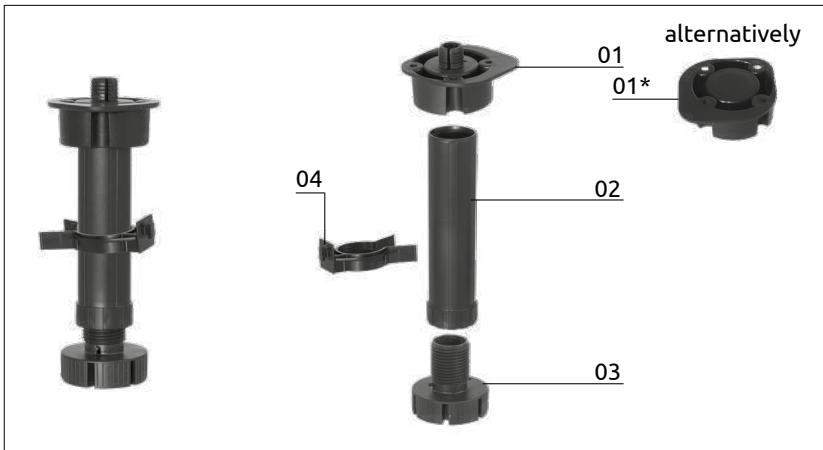

01	SGC	Sottomobile per gamba per cucine (CON PERNO) Foot insert for kitchen leg (With spreading down)	pg. 143
02	PFGC	Prolunga per gamba cucine Extension for kitchen leg	pg. 143
03	PTGC	Piedino a terra filetta o per gambe cucina Threaded glide for kitchen leg	pg. 143
04	GZCI	Gancio per zoccolo cucine con imbocco Clip for kitchen leg with entrance	pg. 144
05	PSGC	Piedino sottomobile con gamba per cucine Foot insert for kitchen leg	pg. 144
06	GZC	Gancio per zoccolo cucine Clip for kitchen base	pg. 143
07	-	Gambo filetta o per piedino cucine Threaded stem for kitchen foot	pg. 144

	Alternative
01 (or 01*)+02	05
03	
06 + (a or b)	04

INDEX

Piedino a terra filetta o per gambe cucina Threaded glide for kitchen leg

PTGC

Codice Code	A	B	C	Nero Black		
				€	Pz x conf Pcs box-bag	MOQ
11.40.569.03	49	18	32	-	-	-

Im. pg. 142

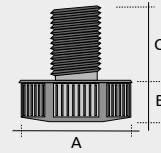

Prolunga per gamba cucina Extension for kitchen leg

PFGC

Codice Code	A	B	Nero Black		
			€	Pz x conf Pcs box-bag	MOQ
11.40.577.03	75	30	-	-	-
11.40.578.03	92	30	-	-	-
11.40.579.03	123	30	-	-	-



Gancio per zoccolo cucina Clip for kitchen base

GZC

Codice Code	A	B	C	Nero Black		
				€	Pz x conf Pcs box-bag	MOQ
11.40.574.02	30	8	4,5	-	-	-



Im.pg.142

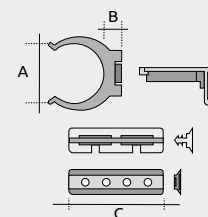

Sottomobile per gambo cucina Foot insert for kitchen leg

SGC

Codice Code	Con perno With spread- ing down	A	B	C	D	E	Nero Black		
							€	Pz x conf Pcs box-bag	MOQ
11.40.575.02	V	58	24	49	32	16	-	-	-
11.40.576.02	-	58	24	49	32	-	-	-	-



Im.pg.142

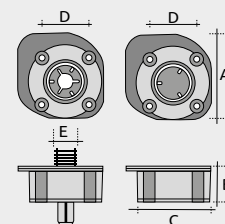

INDEX

PSGC

Piedino sottomobile con gamba per cucine
Foot insert for kitchen leg



Im.pg.142

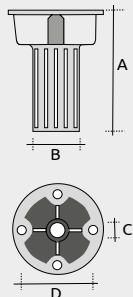

Codice Code	A	B	C	D	Nero Black		
					€	Pz x conf Pcs box-bag	MOQ
11.40.565.03	77	30	M10X2	46	-	-	-
11.40.566.03	97	30	M10X2	46	-	-	-
11.40.567.03	127	30	M10X2	46	-	-	-

GZCI

Gancio per zoccolo cucine con imbocco
Clip for kitchen leg with entrance



Im.pg.142

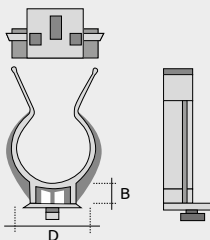

Codice Code	A	B	Nero Black		
			€	Pz x conf Pcs box-bag	MOQ
11.40.568.02	30	9	-	-	-

-

Gambo filetta o per piedino cucine
Threaded stem for kitchen foot



Im.pg.142

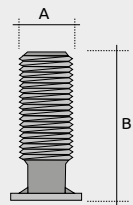

Codice Code	A	B	Zinco cromato Zinc plated		
			€	Pz x conf Pcs box-bag	MOQ
8.01.036.206	M10X2	34	-	-	-

Piedino da avvitare a base triangolare
Triangular foot

PDBT

Codice Code	A	B	C	E	H	L x I	Nero Black		
							€	Pz x conf Pcs box-bag	MOQ
21.29.125.00	5,8	20	16	64	45	130x130	-	1250	1250

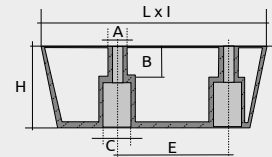

Piedino per divano in acciaio inox
Stainless steel foot for sofa

PPDA

Codice Code	A	B	C	D	E	Ø	Acciaio inox Steel		
							€	Pz x conf Pcs box-bag	MOQ
21.29.120.00	190	17	91	27	71	6	-	50	50

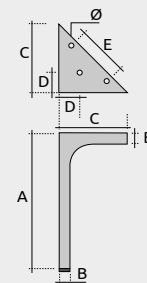

INDEX

ADP

Agganci e distanziale per sedia a pozzetto
Links and spacer for armchair



Codice Code	A	B	C	D	E	F	G	H	I	L	M	N	Nero Black		
													€	Pz x conf Pcs box-bag	MOQ
11.22.150.05	50	42	25	Ø5	9	55	52	32	12	Ø20	Ø8	6	-	200	1000

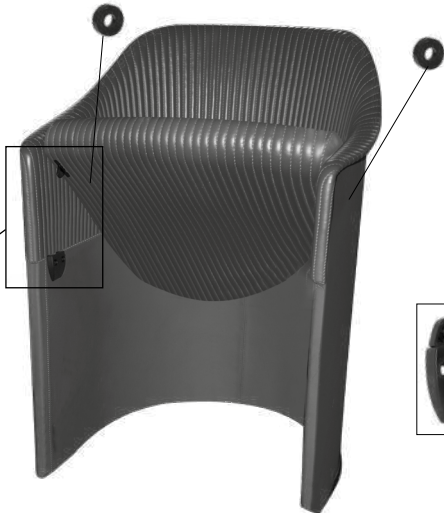
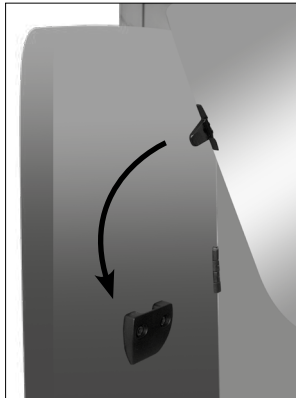
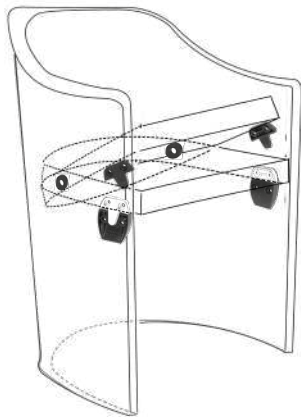
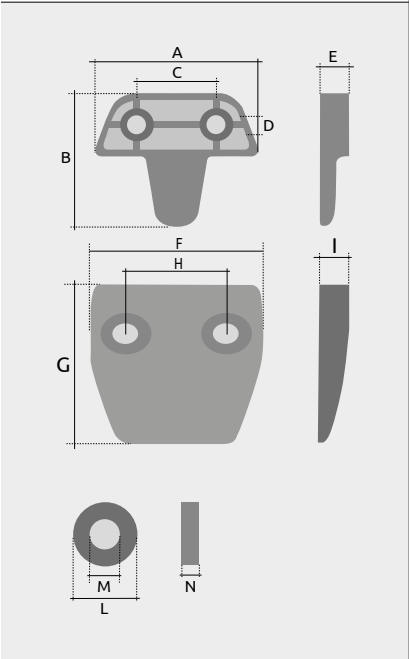

Piedi girevoli per sedie e mobili
Revolving glides for chairs and furniture

GLIS

Codice Code	Gambo montato pin assembled Gambo Ø10-11 Pin Ø10-11	Da Utilizzare con gambi filetati e piastre To use with threaded pin and iron plate	A	B	C	D	E	Nero Black		
								€	Pz x conf Pcs box-bag	MOQ
11.25.255.92	V	-	Ø50	Ø36	Ø10	17	15	-	400	400
11.25.256.92	-	V	Ø50	Ø36	Ø8	17	15	-	400	2000

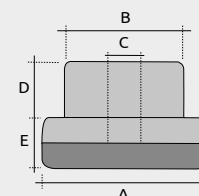

Piedi girevoli per sedie e mobili Crom.G.ZIN.11
Revolving glides for chairs and furniture Chrom G.ZIN.11

GLISC

Codice Code	Gambo montato pin assembled Gambo Ø11 Pin Ø11	A	B	C	D	E	Cromato + nero Chrome plated + black		
							€	Pz x conf Pcs box-bag	MOQ
11.25.239.92	V	Ø50	36	Ø10	17	15	-	400	400

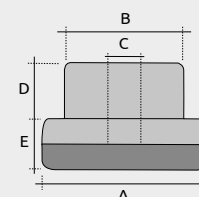

Basi girevoli a campana per sedie e mobili
Revolving glide for chairs and furniture

GLIC

Codice Code	Gambo montato pin assembled Gambo Ø10-11 Pin Ø10-11	Da utilizzare con gambi filetati e piastre To use with threaded pin and iron plate	A	B	C	D	Nero Black		
							€	Pz x conf Pcs box-bag	MOQ
11.25.234.92	V	-	Ø50	13	Ø10	32	-	500	500
11.25.235.92	*	V	Ø50	13	Ø8	32	-	500	1000

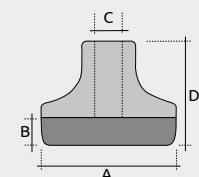

* Con base in PA e coperchio in PP - c= perni come ruote
* With base in PA and cover in PP

INDEX

GLICC

Basi girevoli a campana per sedie e mobili
Revolving glide for chairs and furniture

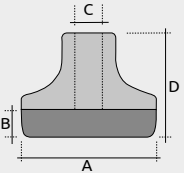
		Codice Code	Gambo montato pin assembled Gambo Ø10-11 Pin Ø10-11	Da Utilizzare con gambi filettati e piastre To use with threaded pin and iron plate	A	B	C	D	Cromato + nero Chrome plated + black		
									€	Pz x conf Pcs box-bag	MOQ
		11.25.236.92	V	-	Ø50	13	Ø10	32	-	500	500

GLIO

Basi girevoli ovali per sedie e mobili
Oval revolving glides for chairs and furniture

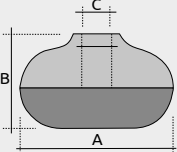
	Codice Code	Gambo montato pin assembled		Da Utilizzare con gambi filettati e piastre To use with threaded pin and iron plate	A	B	C	Nero Black		
		Gambo Pin Ø10	Gambo Pin Ø11					€	Pz x conf Pcs box-bag	MOQ
	11.25.237.92	V		-	Ø65	40	Ø10	-	200	3000
	11.25.237.92		V	-	Ø65	40	Ø10	-	200	200
	11.25.238.92 *	-	-	V	Ø65	40	Ø8	-	200	1000
* Con base in PA e coperchio in PP - c= perni come ruote * With base in PA and cover in PP										

GLIA

Basi girevoli per sedie e mobili
Revolving glides for chairs and furniture

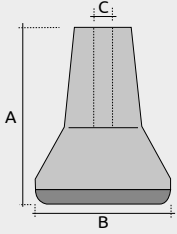
		Codice Code	Gambo montato pin assembled Gambo Ø11 Pin Ø11	A	B	C	Nero Black			
							€	Pz x conf Pcs box-bag	MOQ	
		11.25.258.05	V	69	Ø50	Ø10	-	250	250	
* Con base in PA e coperchio in PP - c= perni come ruote * With base in PA and cover in PP										

GLIT

Basi girevoli per sedie e mobili
Revolving glides for chairs and furniture

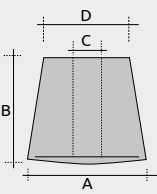
		Codice Code	Gambo montato pin assembled Gambo Ø11 Pin Ø11	Da Utilizzare con gambi filettati e piastre To use with threaded pin and iron plate	A	B	C	D	Nero Black		
									€	Pz x conf Pcs box-bag	MOQ
		11.25.230.02	V	-	Ø35	35	Ø10	Ø28	-	500	1000
		11.25.231.02 *	-	V	Ø35	35	Ø8	Ø28	-	500	500
* Con base in PA e coperchio in PP - c= perni come ruote * With base in PA and cover in PP											

Basi girevoli per sedie e mobili
Revolving glide for chairs and furniture

GLIP

Codice Code	Gambo montato pin assembled Gambo Ø11 Pin Ø11	Da Utilizzare con gambi fileati e piastre To use with threaded pin and iron plate	A	B	C	D	E	Nero Black		
								€	Pz x conf Pcs box-bag	MOQ
11.25.229.05	V	-	Ø50	33	Ø10	5	Ø23	-	250	1000
11.25.228.05	-	V	Ø50	33	Ø8	5	Ø23	-	500	1000

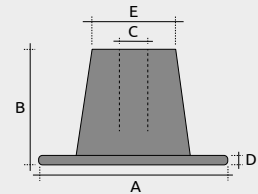

Basi girevoli per sedie e mobili
Revolving glide for chairs and furniture

GLICI

Codice Code	Gambo montato pin assembled Gambo Ø11 Pin Ø11	Gambo montato pin assembled Gambo Ø10 Pin Ø10	A	B	C	Nero Black		
						€	Pz x conf Pcs box-bag	MOQ
11.25.227.05	V	-	Ø50	53	Ø10	-	250	250
11.25.227.05	-	V	Ø50	53	Ø8	-	250	1000

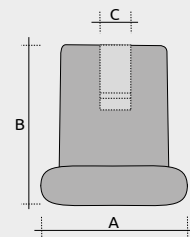

39 | Doppie ruote pivotanti Ø65 | Twin-castors Ø65

DRH

Doppia ruota Ø65
Twin-castors Ø65



Codice Code	Gambo montato pin assembled Gambo Ø11 Pin Ø11	Da Utilizzare con gambi filetati e piastre To use with threaded pin and iron plate	A	B	C	D	E	F	Nero Black		
									€	Pz x conf Pcs box-bag	MOQ
11.25.250.23.N3	✓	-	Ø65	68	54	Ø10	45	22	-	200	200
11.25.355.23.N	-	✓	Ø65	68	54	Ø8	45	22	-	200	200

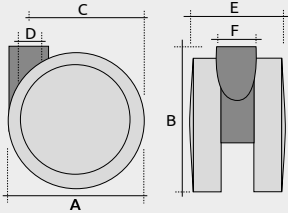

DRHA

Doppia ruota Ø65 autofrenante
Twin-castors Ø65 self-braking



Codice Code	Gambo montato pin assembled Gambo Ø11 Pin Ø11	Da Utilizzare con gambi filetati e piastre To use with threaded pin and iron plate	A	B	C	D	E	F	Nero Black		
									€	Pz x conf Pcs box-bag	MOQ
11.25.251.83.N3	✓	-	Ø65	68	54	Ø10	45	22	-	200	200
11.25.356.83.N	-	✓	Ø65	68	54	Ø8	45	22	-	200	1000

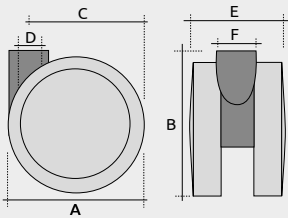

DRHD

Doppia ruota Ø65 (ricoperta in TPU)
Twin-castor Ø65 (covered with TPU)



Codice Code	Gambo montato pin assembled Gambo Ø11 Pin Ø11	Da Utilizzare con gambi filetati e piastre To use with threaded pin and iron plate	A	B	C	D	E	F	Nero Black		
									€	Pz x conf Pcs box-bag	MOQ
11.25.252.55.N3	✓	-	Ø65	68	54	Ø10	45	22	-	200	200
11.25.359.55.N	-	✓	Ø65	68	54	Ø8	45	22	-	200	200

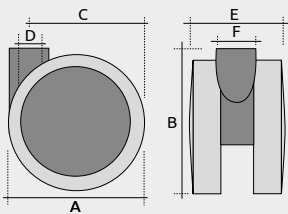

Doppia ruota Ø65 autofrenante (ricoperta in PUR)
Twin-castor Ø65 self-braking (covered with PUR)

DRHAD

Codice Code	Gambo montato pin assembled Gambo Ø11 Pin Ø11	Da Utilizzare con gambi filetati e piastre To use with threaded pin and iron plate	A	B	C	D	E	F	Nero Black		
									€	Pz x conf Pcs box-bag	MOQ
11.25.253.56.N3	V	-	Ø65	68	54	Ø10	45	22	-	200	200
11.25.358.56.N	-	V	Ø65	68	54	Ø8	45	22	-	200	1000

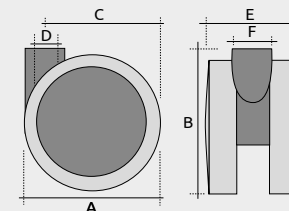

Doppia ruota Ø65 con freno
Twin-castor Ø65 with brake

DRHB

Codice Code	Gambo montato pin assembled Gambo Ø11 Pin Ø11	Da Utilizzare con gambi filetati e piastre To use with threaded pin and iron plate	A	B	C	D	E	F	Nero Black		
									€	Pz x conf Pcs box-bag	MOQ
11.25.350.23.N3	V	-	Ø65	68	54	Ø10	45	22	-	200	1000
11.25.349.23.N	-	V	Ø65	68	54	Ø8	45	22	-	200	200

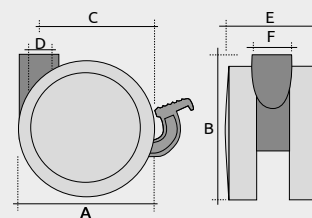

Doppia ruota Ø65 - Cromata
Chromed twin-castor Ø65

DRHC

Codice Code	Gambo montato pin assembled Gambo Ø11 Pin Ø11	A	B	C	D	E	F	Nero + cromato Black + chrome plated		
								€	Pz x conf Pcs box-bag	MOQ
11.25.382.23.C3	V	Ø65	68	54	Ø10	45	22	-	150	600

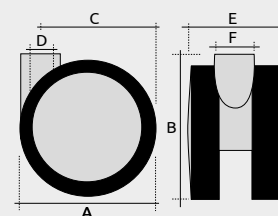

INDEX

DRHDC

Doppia ruota Ø65 (ricop in TPU)-Cromata
Chromed twin-castor Ø65 (covered with TPU)

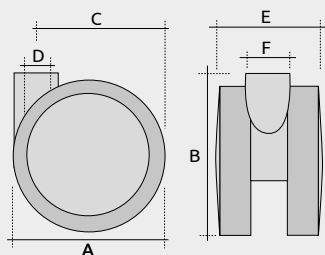

Codice Code	Gambo montato pin assembled Gambo Ø11 Pin Ø11	A	B	C	D	E	F	Cromato Chrome plated		
								€	Pz x conf Pcs box-bag	MOQ
11.25.387.55.C3	V	Ø65	68	54	Ø10	45	22	-	150	600

Doppia ruota Ø50 in PA (ROLLER)
Twin-castor Ø50 (ROLLER) in PA

DRG

Codice Code	Gambo montato pin assembled Gambo Ø11 Pin Ø11	Da Utilizzare con gambi filet ati e piastre To use with threaded pin and iron plate	A	B	C	D	E	Nero Black		
								€	Pz x conf Pcs box-bag	MOQ
11.25.307.80.N3	V	-	Ø50	57.5	50.5	Ø10	55.5	-	250	250
11.25.303.80.N	-	V	Ø50	57.5	50.5	Ø8	55.5	-	300	300

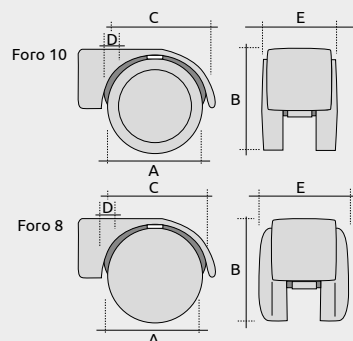

Doppia ruota Ø50 in PA autofrenante
Twin-castor Ø50 in PA self-braking

DRA

Codice Code	Gambo montato pin assembled Gambo Ø11 Pin Ø11	Da Utilizzare con gambi filet ati e piastre To use with threaded pin and iron plate	A	B	C	D	E	Nero Black		
								€	Pz x conf Pcs box-bag	MOQ
11.25.263.83.N3	V	-	Ø50	57.5	50.5	Ø10	55.5	-	250	250
11.25.262.83.N	-	V	Ø50	57.5	50.5	Ø8	55.5	-	300	5000

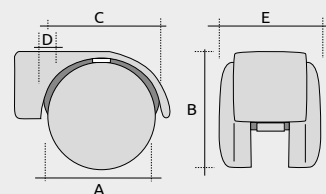

Doppia ruota Ø50 in PA (GLASS)
Twin-castor Ø50 in PA (GLASS)

DRS

Codice Code	Gambo montato pin assembled Gambo Ø11 Pin Ø11	Da Utilizzare con gambi filet ati e piastre To use with threaded pin and iron plate	A	B	C	D	E	F	Nero Black		
									€	Pz x conf Pcs box-bag	MOQ
11.25.270.23.N3	V	-	Ø50	55	48.5	Ø10	54	35	-	250	250
11.25.271.23.N	-	V	Ø50	55	48.5	Ø8	54	35	-	300	5000

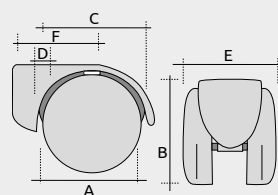

INDEX

DRGC

Doppia ruota Ø50 in PA (ROLLER)
Twin-castor Ø50 in PA (ROLLER)



Codice Code	Gambo montato pin assembled Gambo Ø11 Pin Ø11	Da Utilizzare con gambi filettati e piastre To use with threaded pin and iron plate	A	B	C	D	E	Cromato+Nero Black+Chrome plated		
								€	Pz x conf Pcs box-bag	MOQ
11.25.380.80.C3	✓	-	Ø50	56	50.5	Ø10	55.5	-	200	200
11.25.381.80.C	-	✓	Ø50	56	50.5	Ø8	55.5	-	250	2500

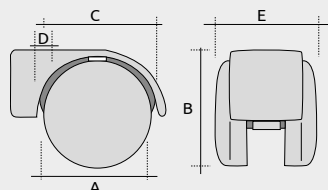

DRV

Doppia ruota Ø50 in PA
Twin-castor Ø50 in PA



Codice Code	Gambo montato pin assembled Gambo Ø11 Pin Ø11	A	B	C	D	E	F	Nero Black		
								€	Pz x conf Pcs box-bag	MOQ
11.25.274.23.N3	✓	Ø50	57,5	51	Ø10	55	41,5	-	200	200

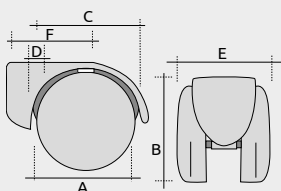

DRVA

Doppia ruota Ø50 in PA autofrenante
Twin-castor Ø50 in PA self-braking



Codice Code	Gambo montato pin assembled Gambo Ø10-11 Pin Ø10-11	A	B	C	D	E	F	Nero Black		
								€	Pz x conf Pcs box-bag	MOQ
11.25.277.84.N3	✓	Ø50	57,5	51	Ø10	55	41,5	-	200	200

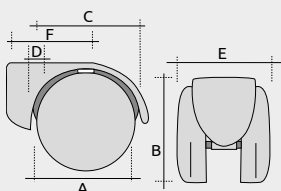

Doppia ruota Ø50 in PA autofrenante (ricoperta in TPU)
Twin-castor Ø50 in PA self-braking (covered with TPU)

DRAD

Codice Code	Gambo montato pin assembled Gambo Ø11 Pin Ø11	Da Utilizzare con gambi fileati e piastre To use with threaded pin and iron plate	A	B	C	D	E	Nero Black		
								€	Pz x conf Pcs box-bag	MOQ
11.25.264.56.N3	V	-	Ø50	57.5	50.5	Ø10	55.5	-	200	200
11.25.265.56.N	-	V	Ø50	57.5	50.5	Ø8	55.5	-	250	5000

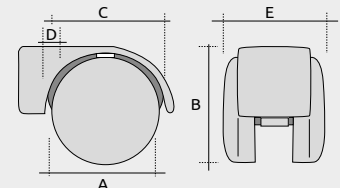

Doppia ruota Ø50 in PA (ricoperta in TPU)
Twin-castor Ø50 in PA (covered with TPU)

DRSD

Codice Code	Gambo montato pin assembled Gambo Ø11 Pin Ø11	A	B	C	D	E	F	Nero Black		
								€	Pz x conf Pcs box-bag	MOQ
11.25.272.55.N3	V	Ø50	55	48.5	Ø10	54	35	-	200	200

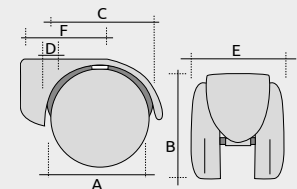

Doppia ruota Ø50 in PA (ricoperta in TPU)
Twin-castor Ø50 in PA (covered with TPU)

DRVD

Codice Code	Gambo montato pin assembled Gambo Ø11 Pin Ø11	A	B	C	D	E	F	Nero Black		
								€	Pz x conf Pcs box-bag	MOQ
11.25.275.55.N3	V	Ø50	57.5	51	Ø10	55	41.5	-	200	200

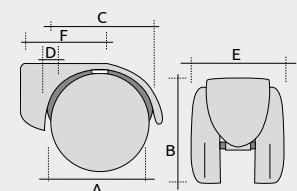

INDEX

DRVAD

Doppia ruota Ø50 in PA (ricoperta in TPU) autofrenante
Twin-castor Ø50 in PA self-braking (covered with TPU)



Codice Code	Gambo montato pin assembled Gambo Ø11 Pin Ø11	A	B	C	D	E	F	Nero Black		
								€	Pz x conf Pcs box-bag	MOQ
11.25.278.56.N3	V	Ø50	57,5	51	Ø10	55	41,5	-	200	200

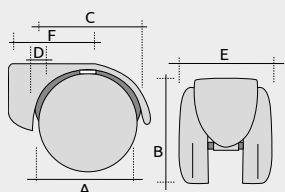

DRGDC

Doppia ruota Ø50 cromata (ricoperta in TPU)
Chromed twin-castor Ø50 (covered with TPU)



Codice Code	Gambo montato pin assembled Gambo Ø11 Pin Ø11	A	B	C	D	E	Nero + cromato Black + chrome plated		
							€	Pz x conf Pcs box-bag	MOQ
11.25.385.55.C3	V	Ø50	57.5	50.5	Ø10	55.5	-	200	200

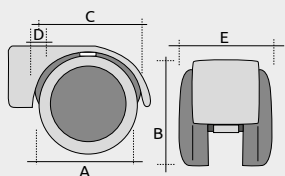

DRGD

Doppia ruota Ø50 in PA (CIP) (ricoperta in TPU)
Twin-castor Ø50 in PA (CIP) (covered with TPU)



Codice Code	Gambo montato pin assembled Gambo Ø11 Pin Ø11	Da Utilizzare con gambi filettati e piastre To use with threaded pin and iron plate	A	B	C	D	E	Nero Black		
								€	Pz x conf Pcs box-bag	MOQ
11.25.291.55.N3	V	-	Ø50	57.5	50.5	Ø10	50.5	-	200	200
11.25.292.55.N	-	V	Ø50	57.5	50.5	Ø8	55.5	-	250	250

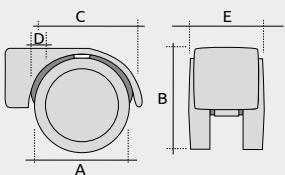

Doppia ruota Ø50 in PA (CIP) con freno
Twin-castor Ø50 in PA (CIP) with brake

DRCB

Codice Code	Gambo montato pin assembled Gambo Ø11 Pin Ø11	Da Utilizzare con gambi filet ati e piastre To use with threaded pin and iron plate	A	B	C	D	E	Nero Black		
								€	Pz x conf Pcs box-bag	MOQ
11.25.287.23.N3	V	-	Ø50	56	47	Ø10	53.5	-	200	200
11.25.286.23.N	-	V	Ø50	56	47	Ø8	53.5	-	250	250

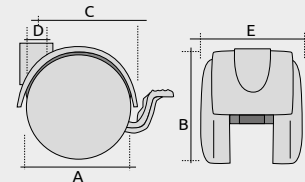

Doppia ruota Ø50 maxi con perno Ø11 montato
Twin-castor Ø50 maxi with 11 mm pin assembled

DRM

Codice Code	A	B	C	D	E	Nero Black		
						€	Pz x conf Pcs box-bag	MOQ
21.25.293.00.N3	50	62	59	8	68	-	150	150

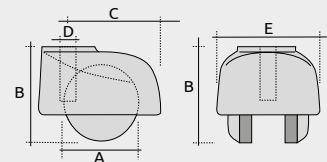

Doppia ruota Ø50
Twin-castor Ø50

DRK

Codice Code	Gambo montato pin assembled Gambo Ø11 Pin Ø11	Da Utilizzare con gambi filet ati e piastre To use with threaded pin and iron plate	A	B	C	D	E	F	Nero Black		
									€	Pz x conf Pcs box-bag	MOQ
11.25.401.23.N3	V	-	Ø50	52	43	Ø10	46	21	-	250	250
11.25.400.23.N	-	V	Ø50	52	43	Ø8	46	21	-	300	5000

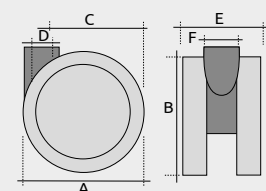

INDEX

DRKA

Doppia ruota Ø50 autofrenante
Twin-castor Ø50 self-braking



Codice Code	Gambo montato pin assembled Gambo Ø11 Pin Ø11	Da Utilizzare con gambi filettati e piastre To use with threaded pin and iron plate	A	B	C	D	E	F	Nero Black		
									€	Pz x conf Pcs box-bag	MOQ
11.25.403.83.N3	✓	-	Ø50	52	43	Ø10	46	21	-	250	250
11.25.402.83.N	-	✓	Ø50	52	43	Ø8	46	21	-	300	5000

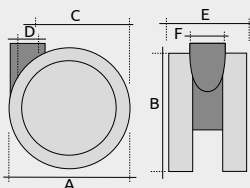

DRKD

Doppia ruota Ø50
Twin-castor Ø50



Codice Code	Gambo montato pin assembled Gambo Ø11 Pin Ø11	Da Utilizzare con gambi filettati e piastre To use with threaded pin and iron plate	A	B	C	D	E	F	Nero Black		
									€	Pz x conf Pcs box-bag	MOQ
11.25.405.55.N3	✓	-	Ø50	52	43	Ø10	46	21	-	200	200
11.25.404.55.N	-	✓	Ø50	52	43	Ø8	46	21	-	250	5000

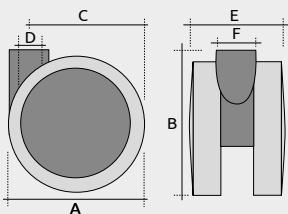

DRKAD

Doppia ruota Ø50 autofrenante (ricoperta in TPU)
Twin-castors Ø50 self-braking (covered with TPU)



Codice Code	Gambo montato pin assembled Gambo Ø11 Pin Ø11	Da Utilizzare con gambi filettati e piastre To use with threaded pin and iron plate	A	B	C	D	E	F	Nero Black		
									€	Pz x conf Pcs box-bag	MOQ
11.25.406.56.N3	✓	-	Ø50	52	43	Ø10	46	21	-	200	200
11.25.407.56.N	-	✓	Ø50	52	43	Ø8	46	21	-	250	5000

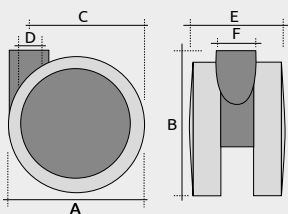

Doppia ruota Ø50 (FAST)
Twin-casters Ø50 (FAST)

DRN

Codice Code	Gambo montato pin assembled Gambo Ø11 Pin Ø11	Da Utilizzare con gambi fileati e piastre To use with threaded pin and iron plate	A	B	C	D	E	Nero Black		
								€	Pz x conf Pcs box-bag	MOQ
11.25.280.73.N3	✓	-	Ø50	55	48	Ø10	54	-	250	250
11.25.281.73.N	-	✓	Ø50	55	48	Ø8	54	-	300	300

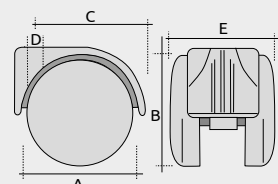

Doppia ruota Ø50 in PP (CIP)
Twin-caster Ø50 (CIP) in PP

DRC

Codice Code	Gambo montato pin assembled Gambo Ø11 Pin Ø11	Da Utilizzare con gambi fileati e piastre To use with threaded pin and iron plate	A	B	C	D	E	Nero Black		
								€	Pz x conf Pcs box-bag	MOQ
11.25.297.73.N3	✓	-	Ø50	56	47	Ø10	53.5	-	250	250
11.25.295.73.N	-	✓	Ø50	56	47	Ø8	53.5	-	300	300

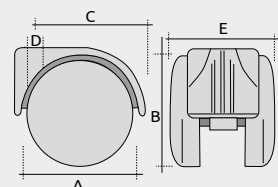



Doppia ruota Ø50 conduttiva tipo H (ROLLER)
Twin wheel conductive castor Ø50 type H (ROLLER)

DRGR

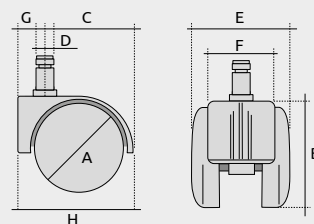
Codice Code	A	B	C	D	E	F	G	H	Nero Black		
									€	Pz x conf Pcs box-bag	MOQ
11.25.410.80N3	Ø50	56	50,5	Ø11	54	36	18,5	69	-	250	250

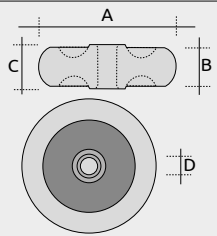

RTL	Rotella Libera Ø47 Free-wheel Ø47									
	Codice Code	A	B	C	D	Nero Black				
						€	Pz x conf Pcs box-bag	MOQ		
	11.25.156.02	47	13	15	6.5	-	1250	1250		
										

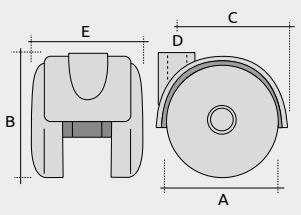
DRC	Doppia ruota Ø40 in PP (CIP) Twin-castor Ø40 in PP (CIP)										
	Codice Code	Gambo montato pin assembled Gambo Ø11 Pin Ø11	Da Utilizzare con gambi filet ati e piastre To use with threaded pin and iron plate	A	B	C	D	E	Nero Black		
									€	Pz x conf Pcs box-bag	MOQ
	11.25.298.73N	-	✓	Ø40	43.5	38	Ø8	38.5	-	500	500
											

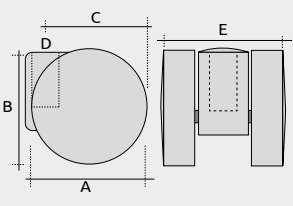
DRBL	Doppia ruota Ø36 "large" per cassetiera Twin-castor Ø36 ("large") for drawer									
	Codice Code	Da Utilizzare con gambi filet ati e piastre To use with threaded pin and iron plate	A	B	C	D	E	Nero Black		
								€	Pz x conf Pcs box-bag	MOQ
	11.25.360.23.N	✓	Ø36	35	34	Ø8	51	-	500	1000
										

Doppia ruota Ø36 "large" per cassettera con freno
Twin-castor Ø36 "large" for drawer with brake

DRBLB

Codice Code	Da Utilizzare con gambi filet ati e piastre To use with threaded pin and iron plate	A	B	C	D	E	Nero Black		
							€	Pz x conf Pcs box-bag	MOQ
11.25.362.23.N	V	Ø36	35	34	Ø8	51	-	500	1000

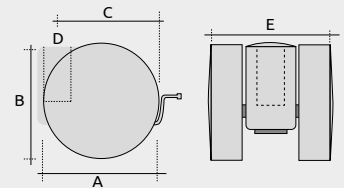

Doppia ruota Ø36 in PA per cassettera
Twin-castor Ø36 in PA "large" for drawer

DRB

Codice Code	Da Utilizzare con gambi filet ati e piastre To use with threaded pin and iron plate	A	B	C	D	E	Nero Black		
							€	Pz x conf Pcs box-bag	MOQ
11.25.267.23.N	V	Ø36	35	34	Ø8	40	-	500	500

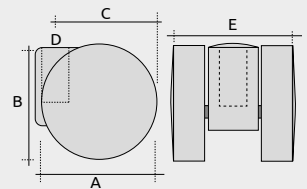

Doppia ruota Ø36 in PA (ricoperta in TPU)
Twin-castor Ø36 in PA "large" for drawer (covered with TPU)

DRBD

Codice Code	Da Utilizzare con gambi filet ati e piastre To use with threaded pin and iron plate	A	B	C	D	E	Nero Black		
							€	Pz x conf Pcs box-bag	MOQ
11.25.390.55.N	V	Ø36	35	34	Ø8	40	-	500	1000

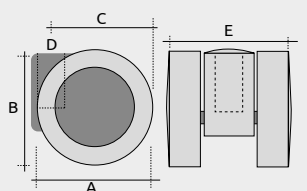

INDEX

DRPF

Doppia ruota Ø35 per fioriera completa di gambo
Twin-castor Ø35 pin for flwers pot holder

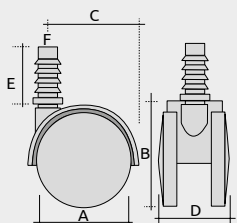

Codice Code	A	B	C	D	E	F	Nero Black		
							€	Pz x conf Pcs box-bag	MOQ
11.25.268.05	35	38	35	29	20	Ø10	-	800	800
11.25.379.05	35	38	35	29	-	Ø14	-	800	800

-

Doppia ruota Ø30 con riduttore 5 alette
Twin-castor Ø30 with ribbed reduction

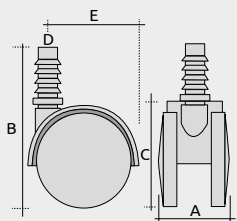

Codice Code	A	B	C	D	E	F	Nero Black		
							€	Pz x conf Pcs box-bag	MOQ
29.10.175.00	29	67	33	Ø12	31	-	-	a richiesta on request	a richiesta on request



01	GRP	Gambo testa esagonale per ruote per pannelli Pin for panel-tray support	pg. 164
02	SRPL	SRPL Supporto ruote per pannelli da 16mm con 1 foro di fissaggio One hole support for panel	pg. 164
03	DRBL	DRBL Doppia ruota Ø36 "large" in PA per cassettera Twin-castor Ø36 in PA "large" for drawer	pg. 160



SRPL

Supporto ruote per pannelli da 16mm con 1 foro di fissaggi
One hole support for panels

Codice Code	A	B	C	D	E	F	G	H	I	Nero Black		
										€	Pz x conf Pcs box-bag	MOQ
11.25.216.02	45	9	15	8	28	10	12	22	16	-	-	20000

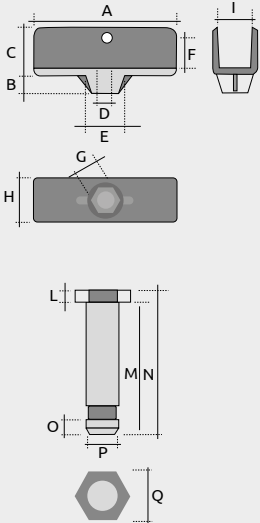

GRP

Gambo testa esagonale per ruote per pannelli
Pin for panel-tray support

Codice Code	L	M	N	O	P	Q	Zinco-cromato Zinc plated		
							€	Pz x conf Pcs box-bag	MOQ
21.25.420.00F	3	33	36	3.65	Ø8	12	-	1200	20000



-

Supporto ruote per pannelli da 15mm con 2 fori di fissaggio
Two holes support for panels

Codice Code	A	B	C	D	E	F	G	H	I	Nero Black		
										€	Pz x conf Pcs box-bag	MOQ
19.16.175.02	70	9	33	8	28	14	12	21	15	-	1000	20000

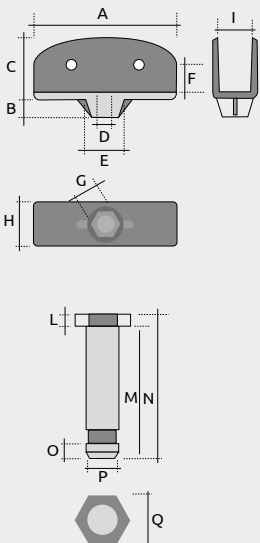



GRP

Gambo testa esagonale per ruote per pannelli
Pin for panel-tray support

Codice Code	L	M	N	O	P	Q	Zinco-cromato Zinc plated		
							€	Pz x conf Pcs box-bag	MOQ
21.25.420.00F	3	33	36	3.65	Ø8	12	-	1200	20000

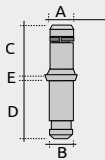

Gambo per basi sedie in FE zincocromato
Iron zinc plated pin for bases

GPB

Codice Code	A	B	C	D	E	Zinco-cromato Zinc plated			
						€	Pz x conf Pcs box-bag	MOQ	
21.25.313.00	Ø11	Ø10	20	23.5	2.5	-	-	-	
21.25.338.00	Ø10	Ø10	20	23.5	2.5	-	-	-	

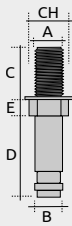

Gambo filetta o in FE zincocromato
Iron zinc-plated threaded pin

GFR

Codice Code	A	B	C	D	E	CH	Zinco-cromato Zinc plated			
							€	Pz x conf Pcs box-bag	MOQ	
21.25.312.00	M6	8	10	23	5	10	-	-	-	
21.25.318.00	M8	8	10	23	5	10	-	-	-	
21.25.310.00	M8	8	15	23	5	10	-	-	-	
21.25.326.00	M8	8	30	23	5	10	-	-	-	
21.25.311.00	M10	8	15	23	5	12	-	-	-	
21.25.325.00	M10	8	18	23	5	12	-	-	-	

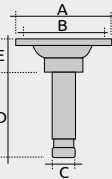

Gambo con piastra quadra in FE zincocromato
Iron zinc-plated plate

GPR

Codice Code	A	B	C	D	E	Zinco-cromato Zinc plated			
						€	Pz x conf Pcs box-bag	MOQ	
21.25.309.00	28X28	19X19	8	23	10	-	-	-	
21.25.337.00	38X38	27X27	8	23	10	-	-	-	
21.25.336.00	42X42	32X32	8	23	13	-	-	-	

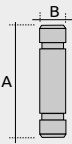

Gambo attacco HI-FI in FE zincocromato
Iron zinc-plated pin for HI-FI

GHI

Codice Code	A	B	Zinco-cromato Zinc plated			
			€	Pz x conf Pcs box-bag	MOQ	
11.25.330.65Y	37	Ø8	-	-	10000	

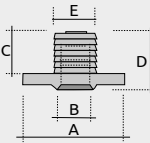

Base attacco gambo HI-FI in PA
Stem for HI-FI in PA

BHI

Codice Code	A	B	C	D	E	Nero Black			
						€	Pz x conf Pcs box-bag	MOQ	
11.25.331.05	30	Ø8	13	16,5	12,3	-	5000	5000	

Gambo godronato in FE zincocromato
Zinc plated knured pin

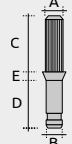
GGR

Codice Code	A	B	C	D	E	Zinco-cromato Zinc plated			
						€	Pz x conf Pcs box-bag	MOQ	
21.25.308.00	8	8	20	23	4	-	-	-	

43 | Doppie ruote pivotanti Ø50 | Twin-castors Ø50 - (2)

OTO50

Ruota Ø50 "OTO50"
Castor Ø50 "OTO50"

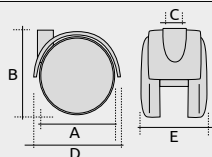

Codice Code	A	B	C	D	E	Nero Black		
						€	Pz x conf Pcs box-bag	MOQ
11.25.453.73	Ø50	54	Ø7	60	51	-	400	400

OTO50CF

Ruota Ø50 "OTO50" con freno
Castor Ø50 "OTO50" with brake

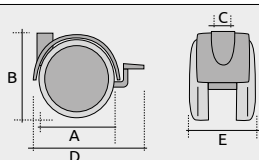

Codice Code	A	B	C	D	E	Nero Black		
						€	Pz x conf Pcs box-bag	MOQ
11.25.455.80	Ø50	54	Ø7	75	51	-	400	400

OTO50RG

Ruota Ø50 "OTO50" con gomma
Castor Ø50 "OTO50" with rubber

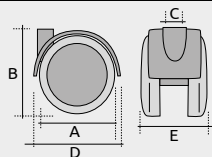

Codice Code	A	B	C	D	E	Nero Black		
						€	Pz x conf Pcs box-bag	MOQ
11.25.461.74	Ø50	54	Ø7	60	51	-	400	400

OTO50RGCF

Ruota Ø50 "OTO50" con gomma e freno
Castor Ø50 "OTO50" - rubber and brake

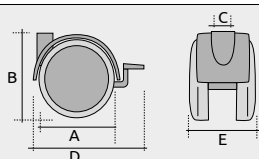

Codice Code	A	B	C	D	E	Nero Black		
						€	Pz x conf Pcs box-bag	MOQ
11.25.462.74	Ø50	54	Ø7	75	51	-	400	400

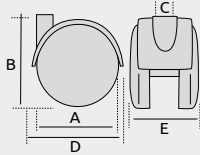
						Ruota Ø40 "OTO40" Castor Ø40 "OTO40"			OTO40
Codice Code	A	B	C	D	E	Nero Black			
						€	Pz x conf Pcs box-bag	MOQ	
11.25.450.73	Ø40	46	Ø7	49	46	-	500	500	

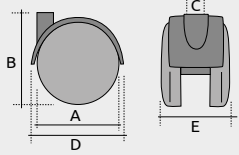
						Ruota Ø40 "OTO40" con freno Castor Ø40 "OTO40" with brake			OTO40CF
Codice Code	A	B	C	D	E	Nero Black			
						€	Pz x conf Pcs box-bag	MOQ	
11.25.451.80	Ø40	46	Ø7	64	46	-	400	400	

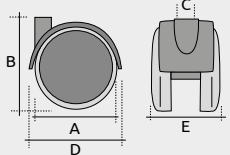
						Ruota Ø40 "OTO40" con gomma Castor Ø40 "OTO40" with rubber			OTO40RG
Codice Code	A	B	C	D	E	Nero Black			
						€	Pz x conf Pcs box-bag	MOQ	
11.25.452.74	Ø40	46	Ø7	49	46	-	500	500	

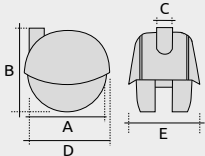
						Ruota Ø40 "SAR40" Castor Ø40 "SAR40"			SAR40
Codice Code	A	B	C	D	E	Nero Black			
						€	Pz x conf Pcs box-bag	MOQ	
11.25.464.73	Ø40	46	Ø7	48	46	-	500	500	

INDEX

SAR35

Ruota Ø35 "SAR35"
Castor Ø35 "SAR35"

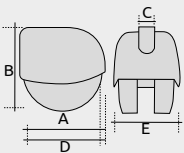

Codice Code	A	B	C	D	E	Nero Black		
						€	Pz x conf Pcs box-bag	MOQ
11.25.463.73 *	Ø35	42	Ø7	44	35	-	500	500



- Non compatibile con GFRO M8X30 - cod. 21.25.474.00
- Not compatible with GFRO M8X30 - cod. 21.25.474.00

ECO35

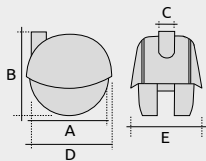

Ruota Ø35 "ECO35"
Castor Ø35 "ECO35"

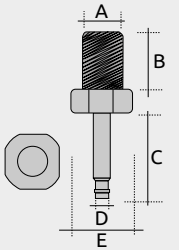

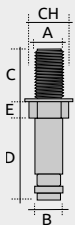

Codice Code	A	B	C	D	E	Nero Black		
						€	Pz x conf Pcs box-bag	MOQ
11.25.465.73	Ø35	38	Ø7	40	35	-	500	500

Gambo ruota filettato Threaded pivot										GFRO
Codice Code	A	B	C	D	E	Zinco-cromato Zinc plated				
						€	Pz x conf Pcs box-bag	MOQ		
21.25.471.00F	M8	15	27	Ø7	12	-	-	-		
21.25.472.00F	M10	15	27	Ø7	12	-	-	-		
21.25.474.00F *	M8	30	24	Ø7	10	-	-	-		
21.25.478.00F	M6	25	24	Ø7	10	-	-	-		

• Non compatibile con SAR 35 - cod. 11.25.463.73
• Not compatible with SAR 35 - cod. 11.25.463.73

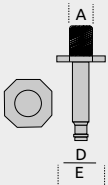
Gambo ruota filettato con rondella Threaded pivot with washer										GFRR
Codice Code	A	B	C	D	E	Zinco-cromato Zinc plated				
						€	Pz x conf Pcs box-bag	MOQ		
21.25.477.00F	M8	10	27	Ø7	10	-	-	-		

Gambo ruota filettato con quadro Threaded pivot with square bush										GFRQ
Codice Code	A	B	C	D	E	Zinco-cromato Zinc plated				
						€	Pz x conf Pcs box-bag	MOQ		
21.25.479.00F	M8	10	26.5	Ø7	17.8	-	-	-		

Gambo ruota godronato Knurled pivot										GGRO
Codice Code	PA	A	B	C	D	E	-			
							€	Pz x conf Pcs box-bag	MOQ	
21.25.481.00F	-	8	12	27	Ø7	12.5	-	-	-	
21.25.482.00F	-	8	20	27	Ø7	12	-	-	-	
11.25.495.05N	V	8	20	27	Ø7	12	-	-	-	
11.25.496.05N	V	10	20	27	Ø7	12	-	-	-	
11.25.497.05N	V	12	20	27	Ø7	15.5	-	-	-	

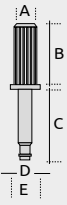

INDEX

GPRO

Gambo con piastra
Pivot with plate

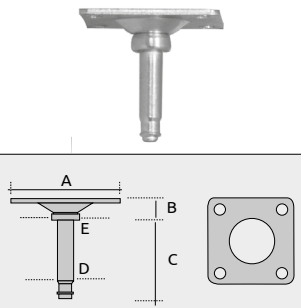
	Codice Code	A	B	C	D	E	Zinco-cromato Zinc plated		
							€	Pz x conf Pcs box-bag	MOQ
	21.25.487.00F	28x28	10	27	Ø7	12	-	-	-
	21.25.488.00F	38x38	10	27	Ø7	12	-	-	-
	21.25.489.00F	42x42	10	27	Ø7	12	-	-	-

GLRO

Gambo liscio o a scatto
Smooth snap stem

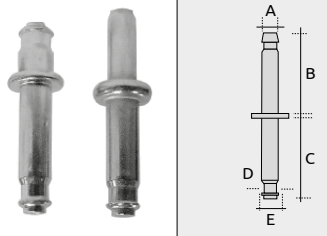
	Codice Code	A scatto* Snap*	A	B	C	D	E	Zinco-cromato Zinc plated		
								€	Pz x conf Pcs box-bag	MOQ
	21.25.491.00F	-	6	28	24	Ø7	12.5	-	-	-
	21.25.492.00F	V	7	26.5	26.5	Ø7	12.5	-	-	-
	21.25.493.00F	V	8	12.5	27	Ø7	12.5	-	-	-
	21.25.494.00F	-	6	17	24	Ø7	12.5	-	-	-

GLBO

Gambo con testa bombata
Roundheaded pivot

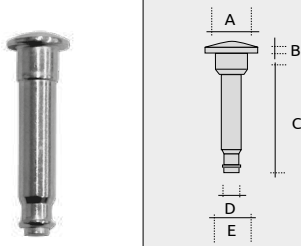
	Codice Code	A	B	C	D	E	Zinco-cromato Zinc plated		
							€	Pz x conf Pcs box-bag	MOQ
	21.25.498.00F	Ø12	3	36	Ø7	8	-	-	-

GPBO

Gambo con seeger montato
Stem with assembled seeger

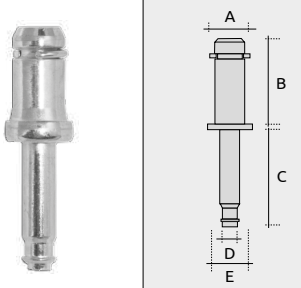
	Codice Code	A	B	C	D	E	Zinco-cromato Zinc plated		
							€	Pz x conf Pcs box-bag	MOQ
	21.25.486.00F	11	20	27	Ø7	14	-	-	-

Chiave esagonale per gambi rotelle in FE zincocromato
Iron zinc-plated hexagonal spanner

CER

Codice Code	A	B	C	D	-		
					€	Pz x conf Pcs box-bag	MOQ
11.25.320.67	10	12	15	80	-	1000	1000
11.25.322.67	12	13	15	80	-	1000	5000

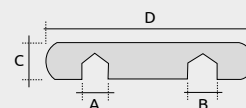

Cacciavite a croce
Cross screwdriver

-

Codice Code	A	B	C	D	-		
					€	Pz x conf Pcs box-bag	MOQ
29.05.130.00	40	47	5.5	25	-	1000	1000

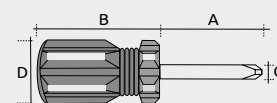

-	Cacciavite a croce Crossed screwdriver	171
-	Doppia ruota Ø30 con riduttore 5 alette Twin-castor Ø30 with 5 ribbed reduction	162
-	Gambo filetta o per piedino cucine Threaded stem for kitchen foot	144
-	Piede per base armadio in PPN PPN cabinet foot for wardrobe	137
-	Supporto ruote per pannelli, con 2 fori Two holes support for panels	164
3R	Riduttori rigati per ruote in PP Striped adapter for castors in PP	98
ADP	Agganci e distanziale per sedia a pozzetto Links and spacer for armchair	146
ADS	Puntali doppio angolare in PE Double angular insert in PE	55
AGO	Agganci ad omega in PP Hooks in PP	67
AO	Attaccapanni ovale in PP Oval clothes stand in PP	93
AO2	Attaccapanni rigido in PP Rigid clothes stand in PP	93
AP4	Appendino a 4 posti Ø50 Cloth hanger 4 places Ø50	87
APF2	Appendino porta flebo 2 post Drip bag trayer 2 places	112
APP	Supporto appendiabiti Clothes-hook support	87
AS	Anello sottopiede in PVC Feet ring in PVC	63
ASC	Puntali per angolari in PE Angular insert in PE	55
ASL	Puntali per angolari a L in PE Angular insert L type in PE	55
ASPF	Attacco superiore porta flebo Top joint for drip trayer	112
AUS	Puntali angolari a U in PVC Angular bases U type in PVC	56
AXA	Anello per appendiabiti in PP Ring for stan-cloth in PP	89
B4G	Bussole filetta e in FE Iron T-nut in FE	128
BAR	Buccola autofilettata e a ragno in PA Spider T-nut in PA (Suited for the assembling of shells)	128
BCM	Bloccchetto chiusura magnetica forza trazione Kg.4 Magnetic closure with force traction of 4 Kg	114
BHI	Base attacco gambo HI-FI in PA Stem for HI-FI in PA	165
BLR	Bloccchetto reggipiani in PP Shelf support in PP	114
BPO	Baccinella base portaombrelli in PP (1) Umbrella stand basins in PP (1)	92
BPO	Baccinelle portaombrelli ovali in PP (2) Oval umbrella stand basins in PP (2)	92
BPO	Baccinelle portaombrelli rotonde in PP (3) Round umbrella stand basins in PP (3)	92
BPP	Base piana a pinza in PE per tondo 8 Clip for chair wire metal for tube 8 mm	46
BPP	Base piana a pinza in PE per tondo 10 Clip for chair wire metal for tube 10 mm	46
BPP	Base piana a pinza in PE per tondo 12 Clip for chair wire metal for tube 12 mm	46
BPP	Base piana a pinza in PE per tondo 14 Clip for chair wire metal for tube 14 mm	46
BPPA	Base piana a pinza antirotazione in PE per tondo 11 Clip for chair wire metal for tube 11 mm non-turning	47
BPPD	Base piana a pinza doppia in PE per tondo 11 Clip for chair wire metal for tube 11 mm non-turning	47
BS	Bracciolo sagomato in PS tubo Ø25 Curved armrest in PS - tube Ø25	67
BSB	Bracciolo sagomato in PS con buccole filettate M6 - in ottone per tubo Ø25 Curved armrest in PS with threaded nuts for tube Ø25	67

BTF	Piedini 4 pzi. per telaio a filo neutri Set of 4 pcs of neutral glides for wireframes	48
BTFA	Piedini 4 pzi con aggancio per telaio a filo Set of 4 pcs of neutral glides with joint for wireframes	48
CCR	Copritesta alettato in PE Ribbed inserts in PE	25
CCRA	Copritesta speciale per vibratore nero Tube cover specific for vib. in black	25
CCRC	Copritesta a 1 aletta in PE Ribbed inserts in PE	26
CCRL	Copritesta alettato in PE Ribbed inserts in PE	26
CCRN	Copritesta alettato rotondo in PE Ribbed round inserts in PE	25
CEI	Copritesta a ellisse in PE Ribbed elliptical insert in PE	43
CEIS	Copritesta a ellisse in PE Ribbed elliptical insert in PE	43
CENI	Copritesta ovale per tubo ellittico Cover cap for elliptical tube	45
CER	Chiave esagonale per gambi rotelle in FE zincocromato Zinc plated hexagonal spanner	171
CESG	Cestino getta carta in PP Paper basket in PP	110
CFS	Copriforo per serramenti in PVC Tube cover for windows in PVC	59
CGQ	Copritesta galvanizzati quadri in ABS Square inserts in ABS	34
CGQ	Copritesta quadri in ABS Square inserts in ABS	34
CGR	Copritesta tondi in ABS Round inserts in ABS	29
CM	Copritesta tubi in FE imbutito Round insert in metal	28
CMR	Copritesta per molle reti in PE neutro Cover caps for net spring in neutral PE	83
COC	Copritesta ovali in ABS- nero-cromato metallizzato Oval insert in ABS black chrome brass plated	43
COI	Copritesta ovali alettati in PE Ribbed oval insert in PE	44
COM	Copritesta in PE ovale con testa in FE cromato Ribbed oval insert in PE with metal top	43
CONI	Copritesta ovale per tubo ovale Cover cap for oval tube	45
CPA	Copriforo tubo Ø50 spess.1 mm per appendiabito Cover cap for tube Ø50 for cloth hanger	87
CPO	Cassetto portaoggetti scorrevole Object-trayer	109
CPOP	Cassetto portaoggetti scorrevole con pioli Object-trayer with pags	109
CPR	Coppia pinze regolabili per tubo ovale 15x30 in PP Clips for oval tube 15x30 in PP	81
CPRX	Coppia pinze regolabili per tubo Ø18-20 in PP Clips for tube Ø18-20 in PP	81
CPTA	Copritesta o puntali ovali testa alta in PE Ribbed oval insert large head in PE	44
CPTA1	Copritesta ovali testa alta 1 aletta in PE One rib oval insert in PE	44
CQI	Copritesta quadri in PE Square inserts in PE	33
CQIN	Copritesta-puntali quadri Square inserts	33
CQM	Copritesta in PE con testa in FE cromato Square inserts in PE with metal top	33
CRG	Copritesta rettangolari in ABS - nero - cromato metallizzato Rectangular insert in ABS - black - Chrome plated	39
CRI	Copritesta rettangolari alettati in PE Rectangular tube cover in PE	36
CRI	Copritesta puntali rettang. alettati in PE Ribbed rectangular insert in PE	38
CRIE	Copritesta in PP estetici rettangolari Rectangular insert in PP	38

CRIN	Copritesta rettangolare Rectangular insert	38	DRHB	Doppia ruota Ø65 con freno Twin-castor Ø65 Ø65 with brake	151
CRIS	Copritesta destro e sinistro per stagge Left and right tube cover for levelling staves	39	DRHC	Doppia ruota Ø65 - Cromata Chromed twin-castor Ø65	151
CRL	Copricerniere per reti letto Hinge cover for bed frames	85	DRHD	Doppia ruota Ø65 (ricoperta in TPU) Twin-castor Ø65(covered with TPU)	150
CRM	Copritesta in PP -testa in FE cromato Ribbed inserts in PE and metal top	27	DRHDC	Doppia ruota Ø65 (ricoperta in TPU)- Cromata Chromed twin-castor Ø65(covered with TPU)	152
CRTM	Copritesta in PE rettangolare con testa in FE Chrome rectangular insert	39	DRK	Doppia ruota Ø50 Twin-castor Ø50	157
CS	Copritesta a sfera in PVC Ball cover in PVC	27	DRKA	Doppia ruota Ø50 autofrenante Twin-castor Ø50 with brake	158
CSA	Coprisaldatura per appendiabito Cover welding for cloth hanger	91	DRKAD	Doppia ruota Ø50 autofren (ricoperta in TPU) Twin-castor Ø50 (covered with TPU)	158
CSB	Coprisaldatura base 5 razze Welding cover for 5 legs bases	66	DRKD	Doppia ruota Ø50 (ricoperta in TPU) Twin-castor Ø50 with brake	158
CSL	Cuscinetto per rivettatura a strappo in PA testa liscia Ball bearings in PA with smooth head (Suitable for drawers and etc.)	101	DRM	Doppia ruota Ø50 maxi con perno Ø11 montato Twin-castor Ø50 maxy with 11 mm pin assembled	157
CSO	Cuscinetto a sfera in PA Ball bearing in PA (Suitable for drawers and etc.)	101	DRN	Doppia ruota Ø50 (FAST) Twin-castor Ø50 (FAST)	159
CSPR	Copritesta semiovale porta ruote Semiaoval tube cover for castors	66	DRPF	Doppia ruota Ø35 per fioriera completa di gambo Twin-castor Ø35 pin for flowers pot holder	162
CSS	Cuscinetto per rivettatura a strappo in PA Ball bearings in PA (Suitable for drawers and etc.)	102	DRS	Doppia ruota Ø50 in PA (GLASS) Twin-castor Ø50 in PA (GLASS)	153
CTM	Copritesta alettato in PE con testa in FE cromato Ribbed inserts in PE with metal head	26	DRSD	Doppia ruota Ø50 in PA (ricoperta in TPU) Twin-castor Ø50 in PA (covered with TPU)	155
CVIE	Copritesta viti a testa cilindrica in PE (con esagono incassato per vite 6MA) Screw cover in PE (With exagon for screw 6MA)	114	DRV	Doppia ruota Ø50 in PA Twin-castor Ø50 in PA	154
DB	Tubetto distanziatore in PP Spacer in PP	69	DRVA	Doppia ruota Ø50 in PA autofrenante Twin-castor Ø50 in PA with brake	154
DCA	Dadi con alette in PS antiurto con buccola in metallo filettato Wing screws in PS with zinc-plated bolt	127	DRVAD	Doppia ruota Ø50 in PA (ricoperta in TPU) autofrenante Twin-castor Ø50 in PA with brake (covered with TPU)	156
DGA	Dadi con alette in PS antiurto con gambo FE zincocromato Wing screws in PS with zinc-plated bolt	127	DRVD	Doppia ruota Ø50 in PA (ricoperta in TPU) Twin-castor Ø50 in PA (covered with TPU)	155
DP	Distanziatore a pinza in PE Saddle feet in PE	63	DU01	Disco porta ombrelli TREE Umbrella stand-plate TREE	91
DPO	Disco porta ombrelli a 4 posti in PP Umbrella stand plate with 4 places in PP	91	DZB	Distanziatore bombato zigrinato in PE Round spacer in PE	70
DPOC	Disco porta ombrelli a 4 posti in PP Umbrella stand plate with 4 places in PP	91	DZC	Distanziatore conico nero Spacers with hole	70
DPOQ	Disco porta ombrelli a 4 posti in PP Umbrella stand plate with 4 places in PP	91	DZL	Distanziatore liscio in PE Round spacer in PE	70
DR	Tubetto distanziatore in PE Spaces in PE	69	EA	Puntali angolari in PE Angular insert in PE	56
DRA	Doppia ruota Ø50 in PA autofrenante (BRAKE) Twin-castor Ø50 with brake in PA	153	EAL	Puntali angolari base dritta in PE Angular insert in PE	56
DRAD	Doppia ruota Ø50 in PA autofrenante (ricoperta in TPU) Twin-castor Ø50 with brake in PA (covered with TPU)	155	EB	Puntali a botte in PVC Outer caps in PVC	51
DRB	Doppia ruota Ø36 in PA per cassetiera Twin-castor Ø36 in PA for drawer	161	EBI	Puntali per brande inclinato 20° in PE Inclined 20° insert in PE	83
DRBD	Doppia ruota Ø36 in PA (ricoperta in TPU) Twin-castor Ø36 in PA (covered with TPU)	161	EC	Puntali a campana in PVC Outer caps in PVC	51
DRBL	Doppia ruota Ø36 "large" per cassetiera Twin-castor Ø36 ("large") for drawer	160	ECO35	Ruota Ø35 "ECO35" Castor Ø35 "ECO35"	168
DRBLB	Doppia ruota Ø36 "large" per cassetiera con freno Twin-castor Ø36 "large" for drawer with brake	161	EF	Puntale esterno trasparente con feltro Outer caps with felt pads	52
DRC	Doppia ruota Ø40 PA (CIP) Twin-castor Ø40 in PA (CIP)	159-160	EIA	Puntali a ellisse alettati in PE Ribbed elliptical insert in PE	40
DRCB	Doppia ruota Ø50 in PA (CIP) con freno Twin-castor Ø50 in PA (CIP) with brake	157	EIAD	Puntali a ellisse alettati in PE Ribbed elliptical insert in PE	40
DRG	Doppia ruota Ø50 in PA (ROLLER) Twin-castor Ø50 (ROLLER) in PA	153	EIADI	Puntali a ellisse inclinati 15° in PE Elliptical inclined 15° ribbed insert in PE	41
DRGC	Doppia ruota Ø50 cromata (ROLLER) Twin-castor Ø50 in PA (ROLLER)	154	EIAI	Punta ellisse inclinata 10° in PE Elliptical inclined ribbed insert 10° in PE	40
DRGD	Doppia ruota Ø50 in PA (ricop. in TPU) Twin-castor Ø50 in PA (CIP) with brake	156	EIAS	Puntali a ellisse in PE Ribbed elliptical insert in PE	40
DRGDC	Doppia ruota Ø50 cromata (ricoperta in TPU) Chromed twin-castor Ø50 (covered with TPU)	156	EL	Puntali bombati lunghi in PVC Outer caps in PVC	50
DRGR	Doppia ruota Ø50 conduttiva tipo H (ROLLER) Twin wheel conductive castor Ø50 type H (ROLLER)	159	ERI	Puntali inclinati 20° in PVC Round 20° inclined insert in PVC	52
DRH	Doppia ruota Ø65 Twin-castor Ø65	150	ERL	Punt. est.rett 15x30 Outer square caps 15x30	52
DRHA	Doppia ruota Ø65 autofrenante Twin-castor Ø65 with bracke	150	ES	Espansori in PE per PSE 4 - 5 - 8 - 9 Insert for PSE 4-5-8-9	141
DRHAD	Doppia ruota Ø65 autofrenante (ricoperta in PUR) Twin-castor Ø65 with brake (covered with PUR)	151	ETL	Puntale esterno leggero in PE Light outer caps in PE	51

EX	Puntali export in PVC Outer caps in PVC	50
FBP	Ferma battute porte in PVC Door buffer in P C	72
FCV	Fermacristalli con vite in FE con testa cromata o ottonata Glass blocking FE screws head chromed brassed	98
FP	Fermaportine in PS Doorstop in PS	115
FPST	Feltro per piedino tubo slitta Felt for wire frame clip black	47
GAS	Griglia per armadietti spogliatoio con appendino in PST Grid for locker with cloth hanger in PST	96
GASD	Griglia per armadietti spogliatoio con appendino in PST Grid for locker with cloth hanger in PST	96
GCS	Coppia guide con pioli per cassetto portaoggetti Pair of guides for object tray	109
GFR	Gambo filetta o in FE zincocromato Iron zinc plated threaded pin	165
GPRO	Gambo ruota filetta o Threaded pivot	169
GFRQ	Gambo ruota filetta o con quadro Threaded pivot with square bush	169
GFRR	Gambo ruota filetta o con rondella Threaded pivot with ring	169
GGA	Giunto girevole per attaccapanni in PS Turning joint in PS	90
GGR	Gambo godronato in FE zincocromato Zinc plated knured pin	165
GGRO	Gambo ruota godronato Knurled pivot	169
GHI	Gambo attacco HI-FI in FE zincocromato Iron zinc plated pin for HI-FI	165
GLBO	Gambo con testa bombata Roundheaded pivot	170
GLIA	Basi girevoli per sedie e mobili Revolving glide for chairs and furniture	148
GLIC	Basi girevoli a campana per sedie e mobili Revolving glide for chairs and furniture	147
GLICC	Basi gir a campana per sedie e mobili Revolving glide for chairs and furniture chrom	148
GLICI	Basi girevoli per sedie e mobili Revolving glide for chairs and furniture	149
GLIO	Basi girevoli ovali per sedie e mobili Oval revolving glide for chairs and furniture	148
GLIP	Basi girevoli per sedie e mobili Revolving glide for chairs and furniture	149
GLIS	Piedi girevoli per sedie e mobili Revolving glides for chairs and furniture	147
GLISC	Piedi gir. per sedie e mobili crom Revolving glides for chairs and furniture chrom	147
GLIT	Basi girevoli per sedie e mobili Revolving glide for chairs and furniture	148
GLRO	Gambo liscio o a scatto Smooth snap stem	170
GPB	Gambo per basi sedie in FE zincocromato Zinc plated stem with laking ring	165
GPBO	Gambo con seeger montato Stem with assembled seeger	170
GPG	Gancio porta giacca in PA Hook for jacket in PA	95
GPL	Giunti porta aste letti in PP nero Connectors in black PP	82
GPLD	Giunti porta aste letti doppi in PP nero Double connectors in black PP	82
GPO	Gancio reggi ombrello spogliatoi in PP Umbrella stand in PP	95
GPR	Gambo con piastra quadra in FE zincocromato Iron zinc plated plate	165
GPRO	Gambo con piastra Pivot with plate	170
GRA	Gancetto reggipiani per armadietti Shelf hook for locker	96
GRP	Gambo testa esagonale per ruote per pannelli Pin for panel-tray support	164
GZC	Gancio per zoccolo cucine Clip for kitchen leg	143

GZCI	Gancio per zoccolo cucine con imbocco Clip for kitchen leg with entrance	144
HA01	Appendino 4 posti TREE Cloth hanger 4 places mod. TREE	87
HM01	Appendiabito a muro TREE Coat hook mod. TREE	93
IPF	Innesto porta fleb Joint for drip bag tray	112
IQC	Innesto quadro per letti a castello-PA neutro Square connector for castle bed-neutral PA	79
IRA	Puntali alettati in PE Ribbed inserts for round tubes in PE	18
IRA1	Puntale ad una aletta in PE One rib insert in PE	18
IRA2	Puntale a due alette in PE One rib insert in PE	18
IRAF	Puntali rotondi alettati e filettati in P Threaded round inserts in PP	19
IRAFS	Puntale alettato senza testa per tubo D20 Ribbed inserts for round tubes in PE	19
IRAI	Puntali alettati inclinati 13° in PE Inclined ribbed inserts 13° in PE	22
IRAI	Puntali alettati inclinati 30° in PE Inclined ribbed inserts 30° in PE	22
IRAP	Puntali alettati in PE a base alta Ribbed inserts for round tubes in PE high head	19
IRC	Innesto tondo per letti a castello-PA neutro Round connector for castle-bed -neutral PA	79
IRF	Puntale tondo con feltro Round tube inserts with felt pads	24
IRG	Puntali per ghiera Round inserts with large base	20
IRG	Ghiera per puntali Metal ring for round inserts	20
IRGI	Puntali per ghiera inclin. 12° in PE Round inserts with large base PE inclined 12°	20
IRN	Puntali o sottopiedi in PVC Ribbed inserts in PVC	22
IRTA	Puntale testa alta D22 H57.5 High head insert D22 H57.5	24
IRZI	Puntali con zoccolo inclinati 30° in PE Inserts with inclined base 30° in PE	23
ITLA	Puntali copritesta, a testa liscia in PP Cover tube with smooth head in PP	24
ITQ	Innesti per tubo quadro 20x20 in ABS Tube connector for tube 20x20 in ABS	57
ITQ	Innesti per tubo quadro 25x25 in ABS Tube connector for tube 25x25 in ABS	58
ITR	Innesto per tubi rotondi filetta o in PA Threaded connector for round tube in PA	21-90
ITR	Innesto per tubi rotondi in PS Connectors for round tubes in PS	21-89
ITRV	Innesto con vite per tubi rotondi in PS Connector with screw for round tubes	89
ITSA	Puntali copritesta, a testa sferica alettati in PE Spherical round cover tube in PE	23
ITSA	Puntali copritesta, a testa sferica alettati in PE per tubo spess 2 mm Spherical round cover tube in PE, for tube thickness 2 mm	23
ITSA2	Puntali copritesta, a testa semisferica in PP Spherical round cover tube in PP	24
ITSC	Copritesta alettato in PE con testa sferica in FE cromato Ribbed insert in PE with round metal head	27
ITSQ	Puntale-copritesta quadro con testa tonda Square cover cap with round top	33
IVC	Piedino regol. quadro con base ottagonale Adjustable foot with octagonal base	136
IVC	Piedino regol. quadro con base esagonale Adjustable foot with octagonal base	136
IVC	Piedino regolabile quadro con base rotonda con esagono Square adjustable foot with round base	136
IVR	Piede regolabile con base esagonale Adjustable foot with hexagonal base	137
MAC	Manopole per carriole in PE Handle for wheelbarrow in PE	59
MCE	Maniglia curva ellittica in PP Curved elliptical handle in PP	117

MCL	Maniglia curva larga in PP Wide curved handle in PP	117	PAS	Piastra aggancio attaccapanni spogliatoio in FE cromato Chrome FE plate for cloth hanger	95
MDA	Maniglia in ABS Handle in ABS (in thermosetting composition)	116	PASA	Piedino regolabile Adjustable foot	132
MDB	Maniglia in ABS Handle in ABS (in thermosetting composition)	116	PAT	Protezione aletta thonet in PE Protection thonet fin in P	59
MF	Maniglia a filo in P Thread handle in PP	117	PATC	Pomelli attaccapanni neri-PS, testa FE cromata Black knobs-PS-FE head chromed	88
MI	Maniglia nera in PS antiurto Shock proof handle in PS	119	PATS	Piedino anteriore per telaio slitta D25 Front feet for cantilever D25	65
MIR	Maniglia rotonda in PS antiurto interno liscio Round handle, shock proof in PS	119	PBC	Pomello con testa bombata in ABS filettati 4M Knob with convex head	120
MIS	Maniglia a scatto in PS antiurto Flick handle, shock proof in PS	119	PBF	Paracolpi con chiodo e base in feltro Buffer with nail and base in fel	78
MMC	Maniglia mobili curva in PP Curved handle in PP	116	PBRB	Reg in FE-base in plast-gambo e ghiera in FE zincocromato o ottone Non-tilt adjustable feet with plastic base and zinc-plated brass iron screw	130
MML	Maniglietta in PP Handle in PP	118	PBRC	Reg in FE-base in plast-gambo e ghiera in FE zincocromato o ottone Non-tilt adjustable feet with plastic base and zinc-plated brass iron screw	130
MOB	Maniglia ovale in PS antiurto nera Oval handle in PS (in thermosetting composition)	116	PBRD	Reg in FE-base in plast-gambo e ghiera in FE zincocrom o otton Non-tilt adjustable feet with plastic base and zinc-plated brass iron screw	131
MR	Mensola reggipiano in PA neutro Shelf in neutral PA	103	PBZ	Piede reg in PE nero con base zigrinata - gambo in FE zincocromato Adjustable foot in PE with zinc-plated bolt	134
MS	Borchia liscia per saldatura autogena in FE Smooth iron stud for welding	68	PC	Paracolpi con chiodo in PVC Buffer with nail in P C	77
MSE	Borchia con sporgenza per saldatura elettrica in FE Smooth iron stud for welding	68	PCR	Regolabili cilindrici con base in PE nero e gambo in FE zincocromato Non-tilt adjustable cylindrical feet with black PE base and zinc-plated iron screw	131
MSP	Base plastica in PE Round plastic snap insert in PE	68	PCS	Passacavo per scrivania in PS Cable ducts for desk in PS	101
MSS	Borchia testa sagomata in FE Flat stud in FE	68	PCSO	Puntali copritesta semiovali in PE Ribbed half-oval insert in PE	42
MSSP	Base plastica piana in PE Plastic insert in PE	68	PDBT	Piedino da avvitare a base triangolare Triangular foot	145
MTT	Maniglia trapezoidale in PA Trapezoidal handle in PA (in thermosetting composition)	116	PEE	Puntale esterno ovale in PVC Outer oval cap in PVC	53
MXA	Mozzo per appendiabiti con copertina Clothes-hook with cover	87	PEO	Puntale esterno ovale in PVC Outer oval insert in PVC	53
OAF	Puntali ovali alettati filettati in P Ribbed oval threaded insert in PP	42	PEP	Puntale esterno per piatto in PVC Angular insert in PE	56
OIA	Puntali ovali alettati in PE Ribbed oval insert in PE	41	PF1	Testa rotonda Round head buffe	73
OIADI	Puntale alettato inclinato 15° in PE Inclined 15° ribbed oval insert in PE	41	PF10	Paracolpi testa bombata in PVC Round head buffer in P C	76
OIAS	Puntale ovale alettato in PE Oval ribbed insert in PE	41	PF12	Paracolpi con piolini in PVC Buffer with posts in P C	76
OTO40	Ruota Ø40 "OTO40" Castor Ø40 "OTO40"	167	PF13	Paracolpi rotondi in PVC Round buffers in P C	74
OTO40CF	Ruota Ø40 "OTO40" con freno Castor Ø40 "OTO40" with brake	167	PF14	Paracolpi a tronco di cono in PE Conical buffer in P	74
OTO40RG	Ruota Ø40 "OTO40" con gomma PA6 Castor Ø40 "OTO40" with rubber	167	PF15	Paracolpi con gambo in PE bianchi White insert with bolt in PE	75
OTO50	Ruota Ø50 "OTO50" Castor Ø50 "OTO50"	166	PF16	Paracolpi con 2 gambi in PE bianchi White insert with 2 bolts in PE	75
OTO50CF	Ruota Ø50 "OTO50" con freno Castor Ø50 "OTO50" with brake	166	PF2	Testa bombata Round head buffe	73
OTO50RG	Ruota Ø50 "OTO50" con gomma Castor Ø50 "OTO50" with rubber	166	PF3	Testa piatta Flat head buffe	73
OTO50RGCF	Ruota Ø50 "OTO50" con gomma e freno Castor Ø50 "OTO50" with rubber andbrake	166	PF3	Testa piatta trasparente in PVC Transparent flat buffer in C	74
P2GL	Piedino per gambe legno in PE Glide in PE for wooden legs	115	PF3B	Testa piatta in PE nero Transparent flat buffer in	75
P2P	Pinza a 2 pioli in PE Pillars two post in PE	64	PF3B	Testa piatta trasparente in PVC Transparent flat buffer in C	75
P2PA	Pinza a 2 pioli in PE Pillars two post in PE	64	PF4	Testa rettangolare Rectangular head buffe	74
P2PF	Pattino con feltro a 2 perni Plier two posts with felt	64	PF5	Testa bassa Low head buffe	74
P4P	Paracolpi 4 pezzi per stendibiancheria in PE Inserts in 4 pcs	75	PF6	Paracolpi con chiodo testa rotonda in PE bianchi Round head buffer with nail in PE	77
PAP	Pomelli attaccapanni in ABS Ball knobs in ABS	88	PF7	Paracolpi testa bombata in PVC Buffers with round head in P C	76
PAR	Piedino a 90° antiribaltamento in PP Feet 90° antiupsetting in PP	64	PF8	Paracolpi con 2 chiodi in PE bianchi Buffer with double nail in P	77
PARP	Piedino antiribaltamento in PP Anti-upsetting feet in PP	65	PF9	Paracolpi testa rotonda in PVC Round head buffer in P C	76
PART	Piedino antiribaltamento per telaio slitta D25 Anti-upsetting feet for cantilever D25	65	PFB	Pinze ferma brande in PP Clips in PP	79

PFB	Pinze ferma brande in PP neutro (1) Clip in neutral PP (1)	79	PPG	Profila o rotondo in PVC rigido Profile over in rigid PVC	100
PFB	Pinze ferma brande in PP neutro (2) Clip in neutral PP (2)	80	PPL	Puntali per piedi letto in PE Insert in PE	52-84
PFF	Paracolpi a perno con feltro Push in feet with felt pad	75	PPML	Piedino per meccanismo letto Adjustable foot for bed mechanism	135
PFGC	Prolunga per gamba cucine Extension for kitchen leg	143	PPP	Paracolpi con chiodo e pattino in plastica Buffer with nail and plastic op	78
PFM	Piedino fisso per mobilett Fixed glide for cabinets	115	PPS	Pomolo per appendiabito in ABS Knob for cloth hanger in ABS	88
PFFPA	Piedino per fissaggio panc Foot for bench fixing	137	PPTF	Prolunga per piedini con aggancio per telaio a filo neutro (per BT A) Neutral joint for glides BTFA	48
PFS	Pomelli filettati sferici in ABS (1) Ball knobs in ABS (1)	88	PQR	Profila o quadro e rettangin PVC rigido Rectangular square cover profile in rigid P C	101
PFS	Pomoli sferici filettati in ABS (2) Threaded knobs in ABS (2)	120	PQS	Pinza quadra per staffa di fissagg Square plier for bracket	103
PGO	Piastra per GPO spogliatoi in FE grezzo Raw FE plate for umbrella stand	95	PR	Perno per rotella RC in PA colore neutro Pivot for castors in neutral PA	103
PGP	Poggiapiedi in PE Foot-rest with holes for screws in PE	100	PRA	Reg in FE-base in plast-gambo e ghiera in FE zincocrom o ottonati Non-tilt adjustable feet with plastic base and zinc-plated brass screw	129
PGS	Piedino per gambe scrivania Flat feet for desk	132	PRB	Reg in FE-base in plast-gambo e ghiera in FE zincocrom o ottonati Non-tilt adjustable feet with plastic base and zinc-plated brass screw	129
PGSA	Piedi snodati con base e gambo alettato in PP Tilt glide with base and ribbed stem in PP	141	PRBG	Piede reg-base grande e esagono mm20 in PA-gambo in FE zincocrom Adjustable foot in PA with big base and hexagonal mm.20 - zinc-plated bolt	135
PGSI	Piedini snodati con base piana in PA Tilt glide base in PA	141	PRC	Regolabili in FE-base in plastica - gambo e ghiera in FE zincocromati con filet o Adjustable foot with plastic base and zinc-plated iron screw	129
PGSR	Piede regolabile per gambe scrivania per tubo Ø60 sp.1mm Adjustable foot for desk legs for tube Ø60 thickness 1 mm	137	PRD	Reg in FE-base in plast con gambo e ghiera in FE zincocrom o ottonati Non-tilt adjustable feet with plastic base and zinc-plated brass screw	129
PGT	Piede regolabile con esagono e vite girevole (base in PA nera o con ghiera cromata e gambo zincocromato) Non-tilt adjustable screw (base in PA or chromed base and zinc-plated iron bolt)	133	PREG	Piede regolabile in PP per vite in FE testa esagonale UNI 5739 Iron non-tilt adjustable feet for screws with hexagonal head UNI 5739	130
PIC	Paracolpi con incavo cilindrici in PVC Cylindrical buffers with hole in P C	71	PREP	Pied reg con base piccola-esag mm20 in PA-gambo in FE zincocromato Adjustable foot in PA with small base and exagon mm. 20 with zinc-plated bolt	135
PIO	Puntali ovali inclinati 12,5° in PE Inclined ribbed oval insert 12,5 in PE	42	PRG	Piedi reg con vite girev a testa esag mm.17 e gambo FE zincocromato Non-tilt adjustable feet (base in PA and zinc-plated iron bolt)	133
PIO	Puntali ovali inclinati alla base 20° e gambo 30° in PE Ribbed oval insert inclined bottom 20° leg 30° in PE	42	PRGB	Piede reg con vite girevole a testa esag mm.17 base e vite in FE zinco-crom) Adjustable feet with revolving screw and hexagonal head mm.17 (base and screw in zinc-plated iron)	133
PIT	Distanziatore con incavo Buffers with hol	71	PRGC	Piede regol con vite girevole a testa esagonale mm.17-Con base e vite FE zincocromate. - PRGB - PRGC - a richiesta si può variare filet o e lunghezza gambi. Adjustable feet with revolving screw and exagonal head mm.17- With base and screw in zinc-plated FE PRGB - PRGC - it is possible to change the thread and the length of bolts iron on demand	134
PMS	Paraspigolo a sezione per mobili in PE Sectional cover corner for furniture in PE	61	PRM	Paraspigoli per mobili in PE Cover corner for furniture in PE	60
PMU	Piedino per mobili regolabile con base snodata. Piedino, dado, base, forniti montati Adjustable tilt glide for furniture. Adjustable foot, bolt and base supplied assembled	136	PRMS	Paraspigolo sagomato per mobili in PE Corner cover for furniture in PE	60
PMU4	Kit 4 piedini per mobili regolabili con base snodata. Kit of four adjustable feet with tilt base for furniture	136	PRMT	Paraspigolo triangolare Triangular corner cover	61
PMUC	Piedino per mobili regolabili con base snodata Adjustable tilt glide for furniture	136	PRP	Regolabili con base in PE nero e gambo in FE zincocromato Non-tilt adjustable feet with black PE base and zinc-plated iron screw	131
POB2	Puntale est. ovale con base inclin. in PVC Oval insert with inclined base in PVC	53	PRS	Piede regolabile stampato in PA Non-tilt adjustable feet in PA	132
PODI	Vaschetta Portadocumenti Impilabile Stackable document tray	110	PS	Con base piana rigata in PE -ghiera in FE crom-gambo in FE zincocrom Adjustable tilt glide in PE and chromed zinc-plated iron screw	138
POMC	Pomello concavo per mobili Knob with concave head	120	PSA	Con base bombata liscia in PE With chromed convex smooth base	138
PORB	Base portaombrelli Umbrella-stand base	92	PSAO	Piedi scala artiglio in PVC Ladder oval feet in PVC	54
POS	Porta oggetti cassetti scrivania in PS Objects-trayer for desk in PS	105	PSAR	Piedi scala artiglio in PVC Ladder feet in PVC	53
POSF	Porta oggetti cassetti scrivania con fermo in PS Objects-trayer with blocking in PS	105	PSB	Con base bombata ricoperta in FE cromato With chromed convex smooth base	138
POSG	Porta oggetti cassetti scrivania in PS Objects-trayer for desk in PS	106	PSC	Con base piana rigata With plane striped base	138
POSGF	Porta oggetti cassetti scrivania con fermo in PS Objects-trayer for desk in PS	106	PSD	Con base piana rigata With plane striped base	138
POSGL	Porta oggetti cassetti scrivania con fermo in PS Objects-trayer with blocking in PS	106	PSE	Piedi snodati con esagono 10 Tilt glide with hexagon 10 mm	139
POSGS	Portaoggetti cassetti scrivania con fermo in PS Objects-trayer with blocking in PS	107	PSE4	Piedi snodati e base in PE piana rigata Tilt glide and plane-striped base in PE	139
POSL	Porta oggetti cassetti scrivania in PS Objects-trayer for desk in PS	105	PSE5	Con base bombata rivestita in FE crom Tilt glide with chromed convex base in Fe	140
POSRS	Portaoggetti con cassetto regolabile per scrivania Objects-trayer with adjustable drawing for desk	107	PSE8	Con base bombata in PE liscia Tilt glide with convex base in PE	140
PP	Paracolpi con chiodo e pattino in FE cromato Buffer with nail and chrome op	78			
PPDA	Piedino per divano in acciaio inox Stainless steel foot for sofa	145			

PSE9	Piedini snodati con base piana Tilt glide with plane base	140	RBV	Riduttore per bloccaggio viti in PE PE adapter for the blocking of screws	98
PSE9F	Piedi snodati con base piana in PP pattino in feltro Tilt glides with plane PP base and felt skid	140	RC	Rotelle cassette in PA Drawer castors in PA (Suitable for drawers and etc.)	102
PSEP	Piedi snod-base piana PA nera-gambo esag mm 10 in FE zincocromato Tilt glide with plane base in PA and zinc-plated iron bolt hexagon 10 mm	141	RFR	Regolabili in FE con base ricoperta in PE Iron non-tilt adjustable feet with base covered in PE	130
PSF	Con base piana in PP nero e gambo in FE zincocromato With plane black PP base and zinc-plated iron bolt	139	RBV	Riduttore per bloccaggio viti in PE PE adapter for the blocking of screws	98
PSG	Piedi snodati con esagono 10 Tilt glide with hexagon 10 mm	139	RC	Rotelle cassette in PA Drawer castors in PA (Suitable for drawers and etc.)	102
PSGA	Piedi snodati con base e gambo alettato in PP Tilt glide with base and ribbed stem in PP	141	RFR	Regolabili in FE con base ricoperta in PE Iron non-tilt adjustable feet with base covered in PE	130
PSGC	Piedino sottomobile con gamba per cucine Foot insert for kitchen leg	144	RIA	Puntali rettangolari alettati in PE Rectangular ribbed inserts in PE	35
PSH	Base in PP nero gambo con esagono 10 Black base in PP with hexagon 10 mm	139	RIAS	Puntale rettangolare sagomato in PE Rectangular shaped insert in PE	36
PSL	Protezione scocche legno in PVC Protection for wooden chairs in PVC	66	RIZ	Puntali rett.inclinato 30° alettati a zoccolo in PE Inclined ribbed rectangular inserts 30° in PE	36
PSP	Piedi scala a pera in PVC Ladder insert in PVC	54	RL	Reggi lamiera @ Gambo per foro Ø5 in PA neutro Metal support leg hole Ø5 in neutral PA	59
PSPO	Puntali scala a pera ovali in PVC Ladder oval feet in PVC	54	RMF	Rondelle per maniglia a filo in P Washers in PP for thread handle	118
PSRS	Reg. snod. Ø80 per scrivania con gambo esag. CH 17 per tubo Ø50 sp.1.5 Adj. tilt glide Ø80 for desk with hexagon. thread CH17 for tube Ø50 thickness 1.5	141	RML	Riduttore per perno godronato in PP Reducer for knurl pin in PP	98
PSTF	Piedino tubo slitta Plastic clip wire frame for felt black	47	RP	Rondelle paracolpi in PVC Washers in PVC	72
PT	Paracolpi troncoconici in PVC Cone buffer in P C	71	RPM	Regolabili con pattini in acciaio Adjustable feet with steel skid (Base in PA and zinc-plated bolt)	133
PTF	Protezione per telaio ovale Protection for oval tube frame	66	RPMG	Regolabile in PE con pattino e ghiera in FE gambo cromato Non-tilt adjustable feet in PE with metal-covered plastic base	132
PTGC	Piedino a terra filetta o per gambe cucina Threaded floor glide for kitchen leg	143	RPN	Piede regolabile piatto Non-tilt adjustable flat fee	132
PTL	Puntale testa larga Ø40 per tubo spess.1 Wide head insert Ø40 with thickness 1 mm	21-84	RR	Riduttore alettato in PE per rotelle PE adapters for castors	97
PTT	Protezione per telaio tondo Protection for round tube frame	66	RS	Rondelle sottoviti in HD e PE HD and PE washers	114
PU01	Base porta ombrelli TREE Umbrella stand base mod. TREE	92	RSS	Rondella sottovite svasata in PA Countersunk washer in PA	71
PUS	Pinza unione sedie per tubo ovale in PP nero Clips for oval tube in black PP	81	RTL	Rotella Libera Ø47 Free-wheel Ø47	160
QAF	Puntali quadri filettati e alettati in P Threaded square ribbed inserts in PP	31	SAGE	Supporto con aggancio per rete elettrosaldata Support with hook for elecrowelded net	85
QAFI	Puntali quadrati filettati e alettati in P Threaded square ribbed insert in PP	32	SAR35	Ruota Ø35 "SAR3" Castor Ø35 "SAR3"	168
QAI	Puntali quadri alettati inclinati 30° in PE Inclined square inserts 30°	31	SAR40	Ruota Ø40 "SAR4" Castor Ø40 "SAR4"	167
QI	Puntali quadri in PVC Square inserts in PVC	31	SARE	Supporto ad arco per rete elettrosaldata Arched support for elecrowelded net	84
QIA	Puntali quadri alettati in PE Square inserts in PE	30	SFS	Staffa di fissaggio scrivania Desk fixing bracket	103
QIAF	Puntale quadro con feltro Square tube insert with felt pad	34	SGC	Sottomobile per gamba per cucine Foot insert for kitchen leg	143
QIAS	Puntali quadri alettati in PE Square inserts in PE	30	SP	Sottopiede a pinza in PE Saddle feet in PE	62
QIZ	Puntali quadri inclinati 10° alettato a zoccolo in PE Inclined ribbed square inserts 10° in PE	31	SPBT	Pinza per tubo D25 P5.5 nera con base tonda Saddle feet with round base	63
RAF	Puntali rettangolari alettati e filettati in P Threaded and ribbed insert in PP	37	SPL	Sottopiede a pinza lungo in PE Saddle feet long type in PE	62
RAFI	Puntali rettangolari in PP con inserto filetta o in ferro Square insert in PP with iron thread	37	SPQ	Sottopiede pinza quadra 25X25 Square feet pillar 25x25	62
RAI	Puntali rettangol alettati incl. in PE Inclined ribbed rectangular inserts in PE	36	SRPL	Supporto ruote per pannelloni 1 foro di fissaggio One hole support for panels	164
RAP	Reggi aste con pioli in PE Rod-trayer with peg in PE	83	STL	Supporto per testate letti in PA Support for the head of beds in PA	84
RAPAL	Reggi aste arcuato con pioli in PE Arched rod-trayer with peg in PE	83	TC	Tubetti paracolpi cieco in PVC Buffers in P C	70
RAR	Reggi aste rettangolare in PE nero Rectangular rod-trayer in black PE	82	TD	Tubetto distanziatore in PE Spacer in PE	69
RBA	Piedi reg base alta PA nero-impronta per chiave esag per avvitamen Non-tilt adjustable hfeet with black PA base for hexagonal screwing	131	TDE	Tubetto distanziatore in PA-FV Spacers in PA-FV	69
RBS	Riduzione per basi cono Ø50 completa di ghiera Reduction for base cone Ø50 complete with ring	113	TDI	Tubetti distanziatori con incavo in PE Spacer in PE with cavity	70
RBSL	Riduzione per basi cono Ø50 senza linguetta di smontaggio Reduction for base cone Ø50 with disassembling tongue	113	TFS	Tappetino forato svuotato in PE PE spacers	72
RBSS	Riduzione per basi cono Ø50 con linguetta di smontaggio Reduction for base cone Ø50 without disassembling tongue	113	V30	Volantino a 3 punte ovale in PP con gambo in FE zincocromato Star knob in PP with zinc-plated bolt	123

VC	Vite per cuscinetti in FE zincato Zinc plated screw for bearings	102
VCE	Volantino EVE cieco M8x14	126
VCF	Volant ciechi in PS antiurto con buccola in metallo filett serie a 6 lobi 6-8 lobe star blind knob in PS with metal threaded bush	125
VFP	Volantino con foro passante in PS con buccola metallo serie 8 lobi Star knob in PS with metal threaded bush	126
VG	Ventose con gambo forato in PVC Buffers with drilled bolt in P C	97
VGE	Volantino EVE con gambo M8x14	124
VGF	Volantino gambo filetta o PS antiurto, 6-8 lobi gambo in FE zincocromato Star knobs with threaded bolt in PSs hock proof	121
VGJ	Volantino jolly in PP con gambo e battuta in FE zincocromato Star knob in PP with zinc-plated thread bolt	123
VIT	Vite per innesti ITR in FE zincocromato Zinc plated screw for connectors ITR	90
VJA	Volant. jolly alto in PP-gambo in FE zincocrom Star knob in PP-zinc-plated bolt	121
VJAB	Volantino jolly alto in PP con battuta in FE e gambo in FE zincocromato Star knob in PP with zinc-plated bolt	122
VJB	Volantino jolly basso in PP con gambo in FE zincocromato Star knob in PP with zinc-plated bolt	121
VJBB	Volant jolly basso in PP -battuta in FE -gambo in FE zincocromato Star knob in PP with zinc-plated bolt	121
VJF	Volantino Jolly basso in PP con buccola in metallo filettat Star knob in PP with metal threaded bush	125
VJS	Volant jolly (PP)-gambo FE zincocrom Star knob (PP) -threaded zinc-plated bolt	122
VJSB	Volantino jolly in PP con battuta in FE Star knob in PP with zinc-plated bolt	122
VLG	Vaschetta lavagna porta gesso in PP Chalk tray in PP	100
VPH	Piede reg in PE nero con base esagonale e gambo in FE zincocromato Adjustable foot in PE with hexagonal base and zinc-plated bolt	135
VPHA	Volantino / Piede reg. in PE nero -base esag e gambo in FE zincocromato Adjustable knob/glide in PE with hexagonal base and zinc-plated bolt	124 134
VPO	Vaschetta porta ombrelli per spogliatoi in PP Umbrella tray in PP	95
VPR	Volantino -Piedino regolabile Knob-adjustable glide	124 134
VS	Ventose con sfera in PVC Buffers with ball in P C	97
VSE	Volantini sottopiastra economici in PP- gambo in FE zincocromato Star knob in PP with zinc-plated bolt	122
VSEB	Volant sottopiastra in PP -battuta in FE e gambo in FE zincocromato Star knob in PP with zinc-plated bolt	123
VTB	Volantino Twist in PP con gambo e battuta in FE zincocromato Star knob in PP with zinc-plated bolt	123
VZC	Volantino in PA -buccola in metallo filettata serie ro ondo zigrinato Star knob in PA with metal threaded bush	125
VZF	Volant- gambo filett in A- gambo in FE zincocrom rotondo zigrinato Knurled knob in PA with zinc-plated bolt	124

Indice immagini esplicative Illustrative images index

BTF-BTFA-PPTF Agganci per telaio Set 4 pcs of neutral glides for wireframes	49
Articoli per reti e letti Articles for bed frames and nets	82-85
Articoli per attaccapanni e portaombrelli Items for clothes and umbrella stands	86
Assemblaggio innesto tubi Connector tube assembling	89-90
Articoli per spogliatoi Changing rooms items	94
Articoli per mobili scuola-uffici School-office items	99
Portaoggetti regolabile per cassetto scrivania Adjustable object tray for desk	104
Cassetto portaoggetti Object tray	108
Vaschetta portadocumenti impilabile Stackable document tray	110
Articoli medico ospedalieri(portafleb) Hospital medical articles (drip bag tray)	111
Piedini per cucine Feet for kitchen furniture	142
Divano con piedini in acciaio inox mod. PPDA Sofa with stainless steel foot mod. PPDA	145
ADP Agganci e distanziale per sedia a pozzetto ADP Links and spacer for armchair	146
Supporto ruote per pannelli Support for panels	163

Ivars TWINS
NETWORK

www.ivars.it |   

